

# DENISON CALZONI Radial Piston Motor Type MR, MRE

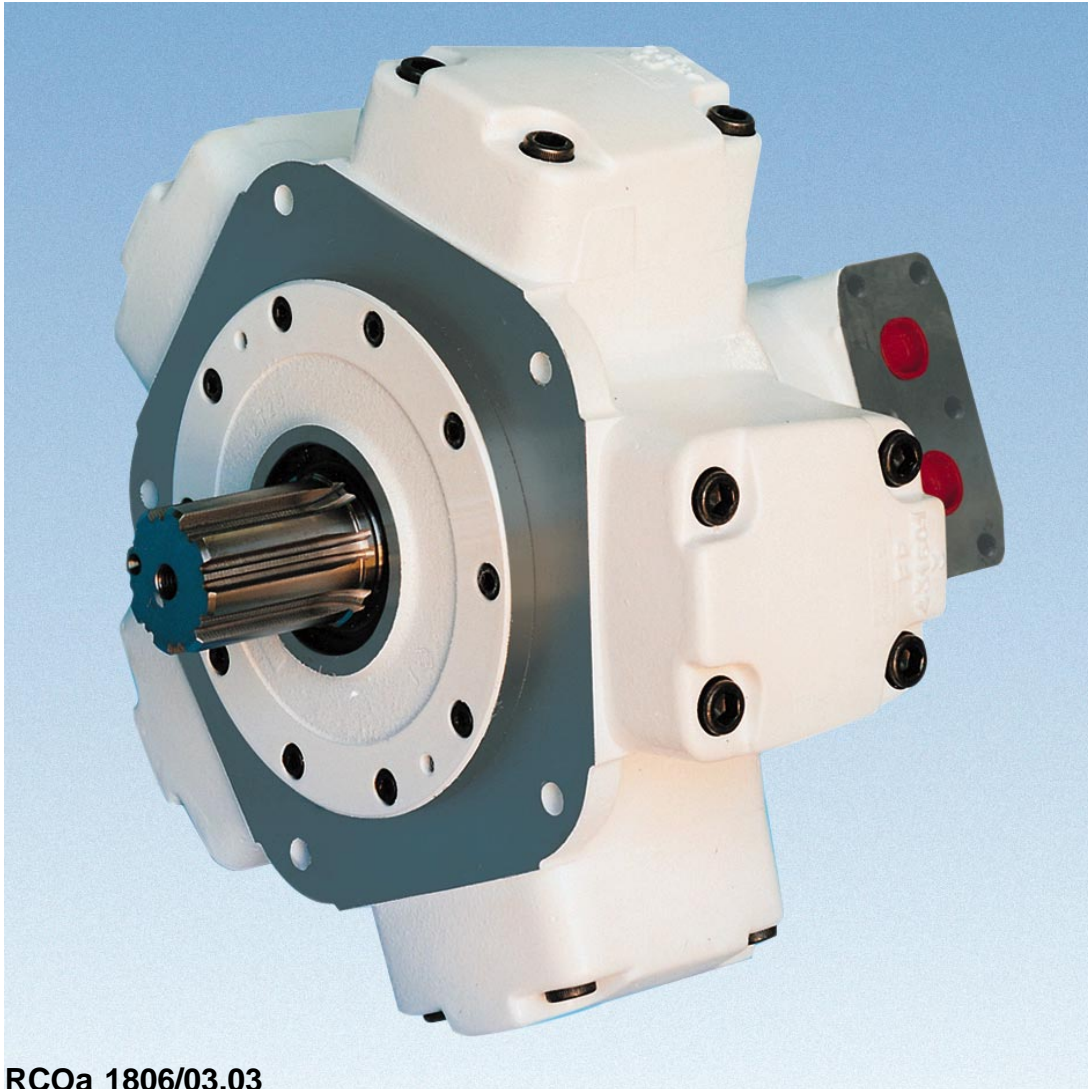

RCOa 1806/03.03

**DENISON** | CALZONI

CONTENTS	PAG.
TABLE OF CONTENTS	2
GENERAL CHARACTERISTICS	3
FUNCTIONAL DESCRIPTION	4
TECHNICAL DATA	5
FLUID SELECTION	6
FLUSHING PROCEDURE	7
OPERATING DIAGRAM MOTOR TYPE MR 33 MR 57 MR 73	8
OPERATING DIAGRAM MOTOR TYPE MR 93 MR 110 MR 125	9
OPERATING DIAGRAM MOTOR TYPE MR 160 MR 190 MR 200	10
OPERATING DIAGRAM MOTOR TYPE MR 250 MR 300 MRE 330	11
OPERATING DIAGRAM MOTOR TYPE MR 350 MR 450 MRE 500	12
OPERATING DIAGRAM MOTOR TYPE MR 600 MR 700 MRE 800	13
OPERATING DIAGRAM MOTOR TYPE MR 1100 MRE 1400 MR 1600	14
OPERATING DIAGRAM MOTOR TYPE MR 1800 MRE 2100 MR 2400	15
OPERATING DIAGRAM MOTOR TYPE MR 2800 MRE 3100 MR 3600	16
OPERATING DIAGRAM MOTOR TYPE MR 4500 MRE 5400 MR 6500	17
OPERATING DIAGRAM MOTOR TYPE MR 7000 MRE 8200	18
OPERATING DIAGRAM (RUNNING PRESSURE DIFFERENCE AT NOLOAD)	19-20
OPERATING DIAGRAM (MOTOR/PUMP: BOOST PRESSURE)	20-21
RADIAL LOAD	22
BEARING LIFE	23
MOTOR DIMENSIONS	24-25
SHAFT END DIMENSIONS	26-27
COMPONENTS FOR SPEED CONTROL	28-29
PIPE CONNECTION FLANGES	30
COUPLINGS - KEY ADAPTERS	31
HOLDING BRAKE - UNIT DIMENSIONS - TECHNICAL DATA	32-33
INSTALLATION NOTES	34
ORDERING CODE	35
SALES AND SERVICE LOCATIONS WORLDWIDE	36

GENERAL CHARACTERISTICS

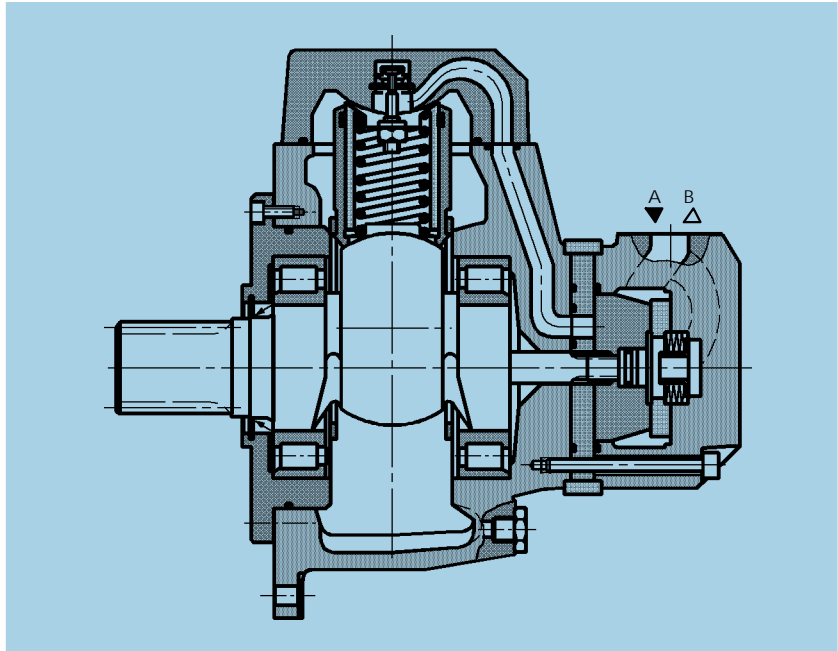

<b>CONSTRUCTION</b>	Fixed displacement radial piston motor
<b>TYPE</b>	MR ; MRE
<b>MOUNTING</b>	Front flange mounting
<b>CONNECTION</b>	Connection flange
<b>MOUNTING POSITION</b>	Any (please note the installation notes on page 34)
<b>BEARING LIFE, RADIAL LOAD</b>	See page 22 and 23
<b>DIRECTION OF ROTATION</b>	Clockwise, anti-clockwise - reversible
<b>FLUID</b>	HLP mineral oils to DIN 51 524 part 2; Fluid type HFB, HFC and Bio-fluids on enquiry. FPM seals are required with phosphorous acid-Ester (HFD)
<b>FLUID TEMPERATURE RANGE</b>	$t$ °F - 22° a + 176° (-30° a +80° C)
<b>VISCOSITY RANGE</b> <sup>1)</sup>	$v$ = 85 to 4635 SUS (18 to 1000 mm <sup>2</sup> /s): Recommended operating range 141 to 230 SUS (30 to 50 mm <sup>2</sup> /s) (see fluid selection on page 6)
<b>FLUID CLEANLINESS</b>	Maximum permissible degree of contamination of fluid NAS 1638 Class 9. We therefore recommend a filter with a minimum retention rate of $\beta_{10} \geq 75$ . To ensure a long life we recommend class 8 to NAS 1638. This can be achieved with a filter, with a minimum retention rate of $\beta_5 \geq 100$ .

1) For different valves of viscosity please contact DENISON Calzoni

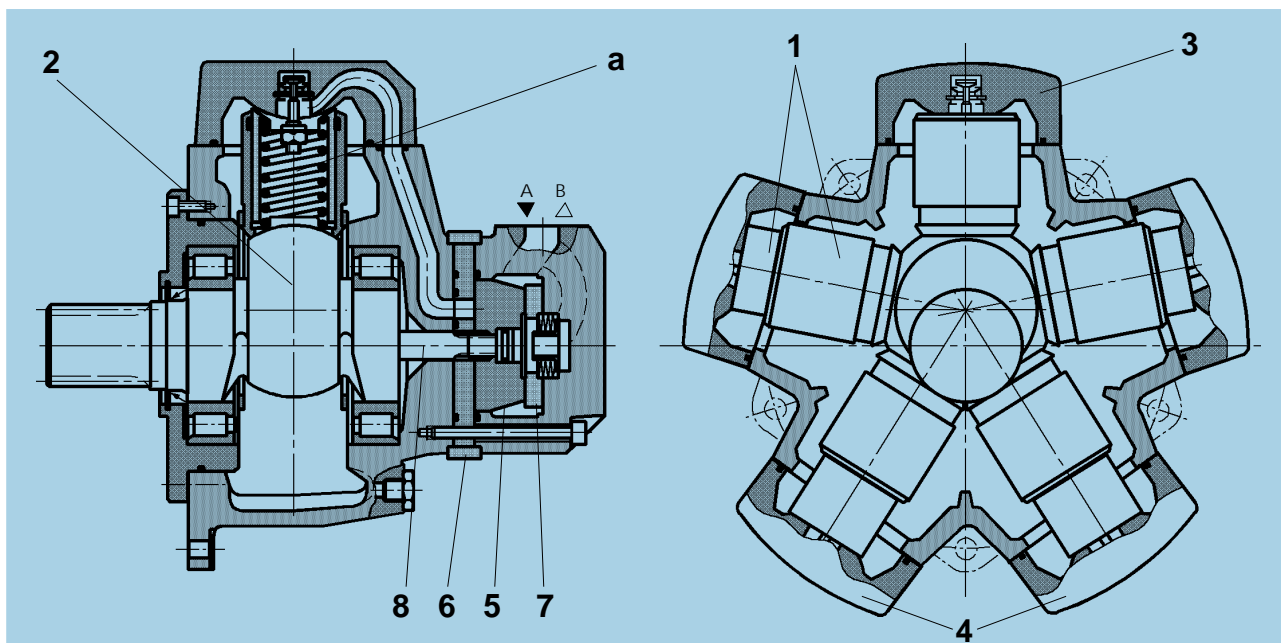

**FUNCTIONAL DESCRIPTION**

The outstanding performance of this motor is the result of an original and patented design. The principle is to transmit the effort from the stator to the rotating shaft (2) by means of a pressurized column of oil (a) instead of the more common connecting rods, pistons, pads and pins.

This oil column is contained by a telescopic cylinder (1) with a mechanical connection at the lips at each end which seal against the spherical surfaces of the cylinder-heads (3) and the spherical surface of the rotating shaft (4).

These lips retain their circular cross section when stressed by the pressure so there is no alteration in the sealing geometry. The particular selection of materials and optimisation of design has minimized both the friction and the leakage.

Another advantage of this design stems from the elimination of any connecting rods, the cylinder can only expand and retract linearly so there are no transverse components of the thrust. This means no oval wear on the moving parts and no side forces on the cylinder joints.

A consequence of this novel design is a significant reduction in weight and overall size compared with other motors of the same capacity.

**TIMING SYSTEM**

The timing system is realized by means of a rotary valve (5) driven by the rotary valve driving shaft (8) that it is connected to the rotating shaft.

The rotary valve rotates between the rotary valve plate (6) and the reaction ring (7) which are fixed with the motor's housing. This timing system is also of a patented design being pressure balanced and self compensating for thermal expansion.

**EFFICIENCY**

The advantages of this type of valve coupled with a revolutionary cylinder arrangement produce a motor with extremely high values of mechanical and volumetric efficiency. The torque output is smooth even at very low speed and the motor gives a high performance starting under load.

TECHINICAL DATA - MOTOR TYPE MR - MRE

Size Motor version	Displacement	Moment inertia of rotating parts	Theoretical specific torque	Min. start. torque / Theoretical torque	Maximum Pressure					Speed range		Maximum output power		Weight	
					input			A+B *	Drain	flushing		flushing			
					cont.	int.	peak			without	with	with-ut	with		
					V	J		%	p	p	p	p	p		n
in <sup>3</sup>	lb.in <sup>2</sup>	lb.ft/psi		psi	psi	psi	psi	psi	rpm	rpm	Hp	Hp	lb		
<b>M R</b>	<b>33</b>	1.96	1.48	0.025	90	3626	4351	6092	5802	72.5 (218 psi with "F1" shaft seal)	1-1400	1-1400	8.9	13.4	66.14
	<b>57</b>	3.44	1.59	0.046	90						1-1300	1-1300	14.8	22.8	66.14
	<b>73</b>	4.43	4.79	0.061	90						1-1200	1-1200	20.2	26.8	83.78
	<b>93</b>	5.65	5.16	0.076	90						1-1150	1-1150	22.8	33.5	83.78
	<b>110</b>	6.65	5.53	0.087	90						1-1100	1-1100	24.1	37.6	83.78
	<b>125</b>	7.61	19.44	0.102	90						1-900	1-900	22.8	33.5	101.4
	<b>160</b>	9.75	19.65	0.129	90						1-900	1-900	26.8	40.2	101.4
	<b>190</b>	11.69	19.89	0.155	90						1-850	1-850	32.2	48.3	101.4
	<b>200</b>	12.16	19.56	0.163	90						1-800	1-800	33.5	51.0	110.2
	<b>250</b>	15.31	20.78	0.203	90						1-800	1-800	42.9	64.4	110.2
	<b>300</b>	18.56	22.36	0.244	90						1-750	1-750	46.9	71.1	110.2
	<b>350</b>	21.33	77.19	0.283	90						1-640	1-640	55.0	83.1	169.8
	<b>450</b>	27.56	78.53	0.366	90						1-600	1-600	61.7	100.6	169.8
	<b>600</b>	37.10	90.58	0.493	90						1-520	1-520	75.1	112.6	213.8
	<b>700</b>	43.09	122.47	0.575	90						1-500	1-500	87.2	130.1	213.8
	<b>1100</b>	68.7	154.28	0.910	90						0.5-330	0.5-330	103.3	159.6	308.6
	<b>1600</b>	97.5	227.73	1.292	90						0.5-260	0.5-260	128.7	193.1	460.8
	<b>1800</b>	110.4	291.86	1.465	90						0.5-250	0.5-250	138.1	205.2	460.8
	<b>2400</b>	139.9	968.89	1.937	90						0.5-220	0.5-220	160.9	245.4	716.5
	<b>2800</b>	170.4	1016.83	2.263	90						0.5-215	0.5-215	170.3	260.2	716.5
<b>3600</b>	221.9	1657.78	2.944	90	0.5-150	0.5-180	164.9	248.1	1120						
<b>4500</b>	274.8	1713.72	3.346	91	0.5-130	0.5-170	187.7	281.6	1120						
<b>6500</b>	394.2	3887.52	5.267	91	0.5-110	0.5-130	221.3	321.8	1764						
<b>7000</b>	408.7	3887.52	5.665	91	0.5-100	0.5-130	228	335.3	1764						
<b>M R E</b>	<b>330</b>	20.28	22.38	0.270	90	3046	3626	5076	5802	72.5 (218 psi with "F1" shaft seal)	1-750	1-750	42.9	65.7	110.2
	<b>500</b>	30.38	78.53	0.403	90						1-600	1-600	61.7	93.9	169.8
	<b>800</b>	49.08	122.47	0.651	90						1-450	1-450	87.2	124.7	213.8
	<b>1400</b>	83.6	154.28	1.109	92						0.5-280	0.5-280	103.3	136.8	319.7
	<b>2100</b>	127.6	291.86	1.693	91						0.5-250	0.5-250	134.1	198.5	487.2
	<b>3100</b>	189.4	1016.83	2.512	91						0.5-215	0.5-215	167.6	254.8	725.3
	<b>5400</b>	329.6	1713.72	4.374	92						0.5-120	0.5-160	187.7	281.6	1129
	<b>8200</b>	502	3887.52	6.657	92						0.5-90	0.5-120	228	335.3	1786

LARGER DISPLACEMENTS ARE AVAILABLE IN THE MRT - MRTE - MRTF MOTOR SERIES

(\* ) Please contact DENISON Calzoni

**EXAMPLE:** At a certain ambient temperature, the operating temperature in the circuit is 122°F (50°C). In the optimum operating viscosity range ( $v_{rec}$ ; shaded section), this corresponds to viscosity grades VG 46 or VG 68; VG 68 should be selected.

**IMPORTANT:** The drain oil temperature is influenced by pressure and speed and is usually higher than the circuit temperature or the tank temperature. At no point in the system, however, may the temperature be higher than 176°F (80°C).

If the optimum conditions cannot be met due to the extreme operating parameters or high ambient temperature, we always recommend flushing the motor case in order to operate within the viscosity limits.

Should it be absolutely necessary to use a viscosity beyond the recommended range, you should first contact DENISON Calzoni for confirmation.

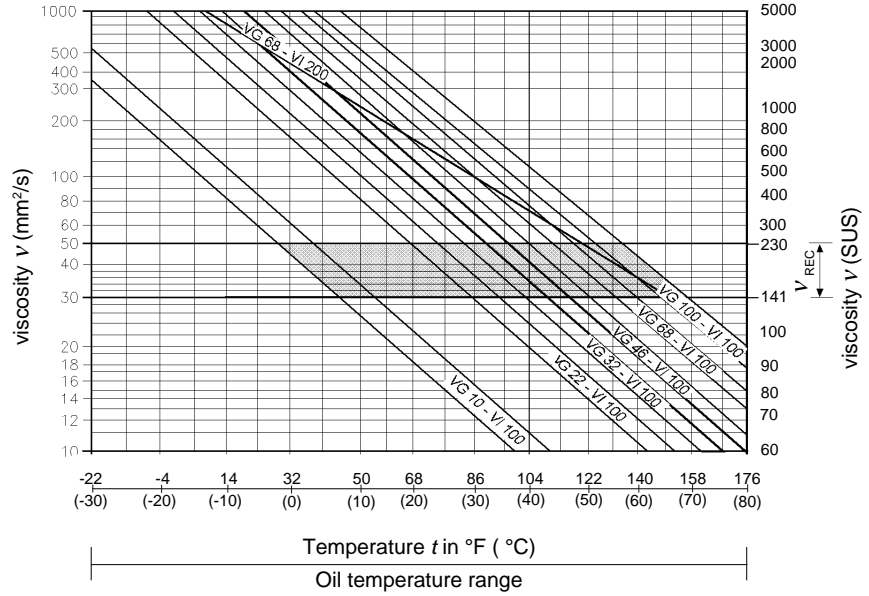

**GENERAL NOTES**

More detailed information regarding the choice of the fluid can be requested to DENISON Calzoni. Further notes on installation and commissioning can be found on page 34 of this data sheet. When operating with HF pressure fluids or bio-degradable pressure fluids possible limitations of the technical data must be taken into consideration, please see information sheet TCS 85, or consult DENISON Calzoni.

**OPERATING VISCOSITY RANGE**

The viscosity, quality and cleanliness of operating fluids are decisive factors in determining the reliability, performance and life-time of an hydraulic component. The maximum life-time and performance are achieved within the recommended viscosity range. For applications that go beyond this range, we recommend to contact DENISON Calzoni.

$$v_{rec} = \text{recommended operating viscosity } 141 \dots 230 \text{ SUS } (30 \dots 50 \text{ mm}^2/\text{s})$$

This viscosity refers to the temperature of the fluid entering the motor, and at the same time to the temperature inside the motor housing (case temperature). We recommend to select the viscosity of the fluid based on the maximum operating temperature, to remain within the recommended viscosity range. To reach the value of maximum continuous power the operating viscosity should be within the recommended viscosity range of 30 - 50 cSt.

**LIMITS OF VISCOSITY RANGE**

For limit conditions the following is valid:

- $v_{min.abs.} = 45 \text{ SUS } (10 \text{ mm}^2/\text{s})$  in emergency, short term
- $v_{min.} = 85 \text{ SUS } (18 \text{ mm}^2/\text{s})$  for continuous operation at reduced performances
- $v_{max.} = 4635 \text{ SUS } (1000 \text{ mm}^2/\text{s})$  short term upon cold start

**CHOOSING THE TYPE OF FLUID ACCORDING TO THE OPERATING TEMPERATURE**

The operating temperature of the motor is defined as the greater temperature between that of the incoming fluid and that of the fluid inside the motor housing (case temperature). We recommend that you choose the viscosity of the fluid based on the maximum operating temperature, to remain within the recommended viscosity range (see diagram). We recommend that the higher viscosity grade must be selected in each case.

**FILTRATION**

The motor life also depends on the fluid filtration. At least it must correspond to one of the following cleanliness.

- class 9 according to NAS 1638
- class 6 according to SAE, ASTM, AIA
- class 18/15 according to ISO/DIS 4406

In order to assure a longer life a cleanliness class 8 to NAS 1638 is recommended, achieved with a filter of  $\beta_s=100$ . In case the above mentioned classes can not be achieved, please consult us.

**CASE DRAIN PRESSURE**

The lower the speed and the case drain pressure, the longer the life of the shaft seal. The maximum permissible housing pressure is

$$p_{max} = 72.5 \text{ psi}$$

If the case drain pressure is higher than 72.5 psi it is possible to use a special 218 psi shaft seal (see page 35, Seals, Code "F1").

**"FPM" SEALS**

In case of operating conditions with high oil temperature or high ambient temperature, we recommend to use "FPM" seals (see page 35, Seals, Code "V1"). These "FPM" seals should be used with HFD fluids.

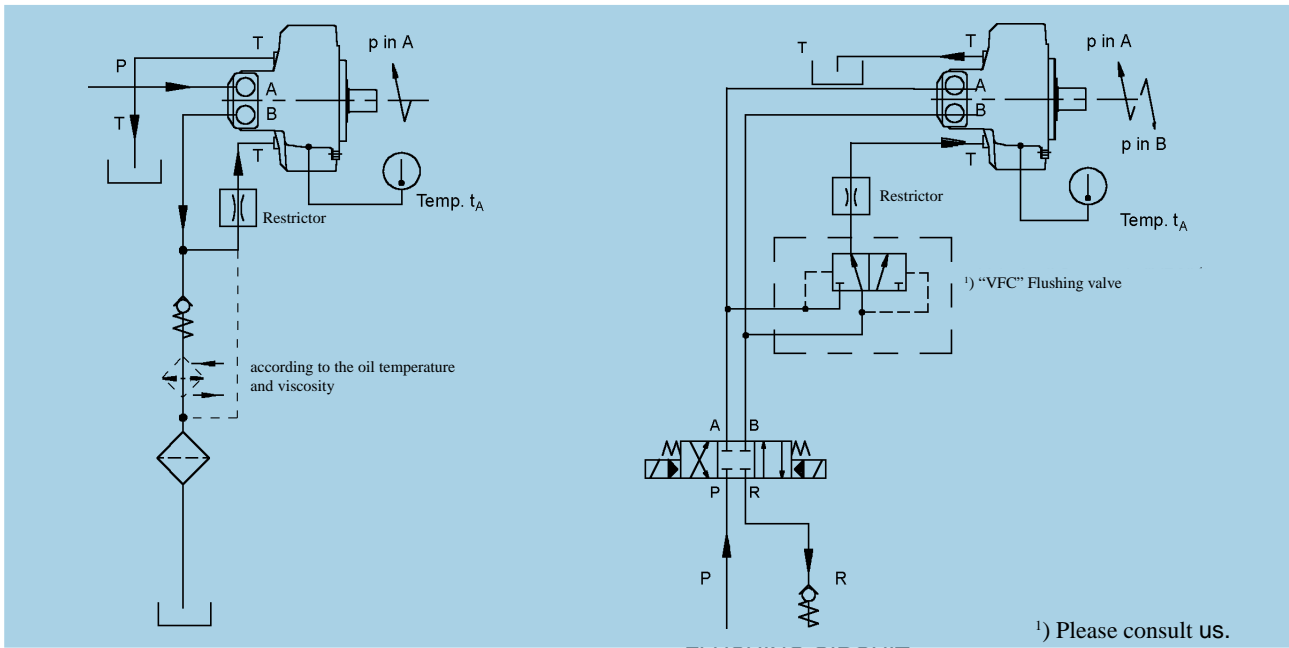

FLUSHING CIRCUIT  
(MONO-DIRECTIONAL ROTATION)

FLUSHING CIRCUIT  
(BI-DIRECTIONAL ROTATION)

**FLUSHING**

The motor case must be flushed when the continuous operating performances of the motor are inside the "Continuous operating area with flushing" (see Operating Diagram from page 8 to page 18), in order to assure the minimum oil viscosity inside the motor case of 141 SUS (30 mm<sup>2</sup>/s) (see page 6 - Fluid Selection). The flushing can be necessary also when the operating performances are outside the "Continuous operating area with flushing", but the system is not able to assure the minimum viscosity conditions requested by the motor as specified at page 6.

**NOTE1:**

The oil temperature inside the motor case is obtainable by adding 5° F (3°C) to the motor surface temperature ( $t_A$ , see figures).

**NOTE2:**

With the standard shaft seal the maximum drain case pressure is 72.5 psi. For the selection of the restrictor, please consult us.

**FLOW**

TYPE	MOTOR VERSION	FLUSHING FLOW
MR	33, 57, 73, 93, 110	Q = 1.3 gpm
MR - MRE	125, 160, 190, 200, 250, 300, 330	Q = 1.6 gpm
MR - MRE	350, 450, 500	Q = 2.0 gpm
MR - MRE	600, 700, 800, 1100, 1400	Q = 2.5 gpm
MR - MRE	1600, 1800, 2100	Q = 4.0 gpm
MR - MRE	2400, 2800, 3100, 3600, 4500, 5400, 6500, 7000, 8200	Q = 5.3 gpm

OPERATING DIAGRAM

(average values) measured at  $V = 167 \text{ SUS}$  ( $36 \text{ mm}^2/\text{s}$ );  $t = 113^\circ\text{F}$  ( $45^\circ\text{C}$ );

$p_{\text{outlet}} = 0 \text{ psi}$  (0 bar)

- 1 Output power
- 2 Intermittent operating area
- 3 Continuous operating area with flushing
- 4 Continuous operating area
- 5 Inlet pressure
- $\eta_t$  Total efficiency
- $\eta_v$  Volumeter efficiency

MR 33

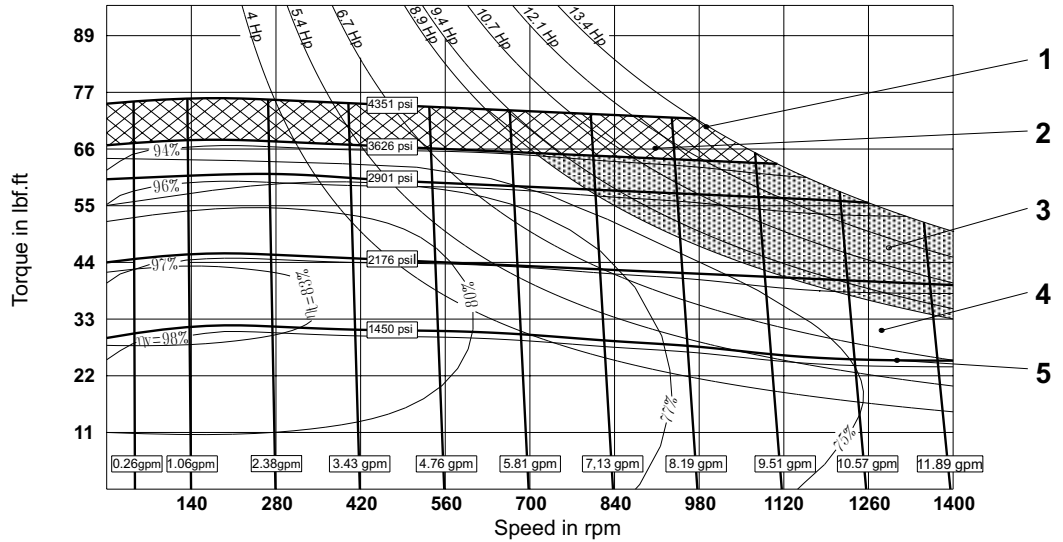

MR 57

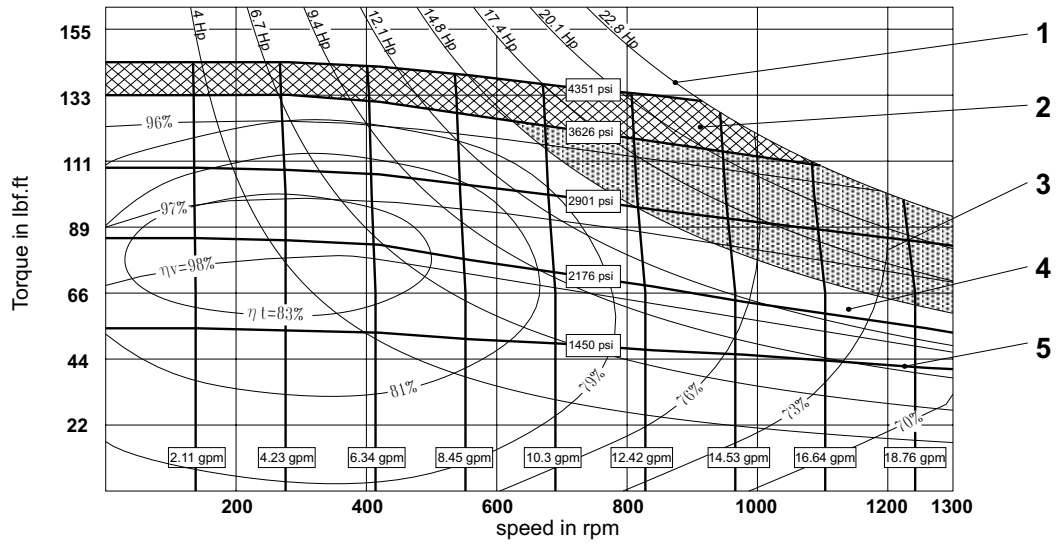

MR 73

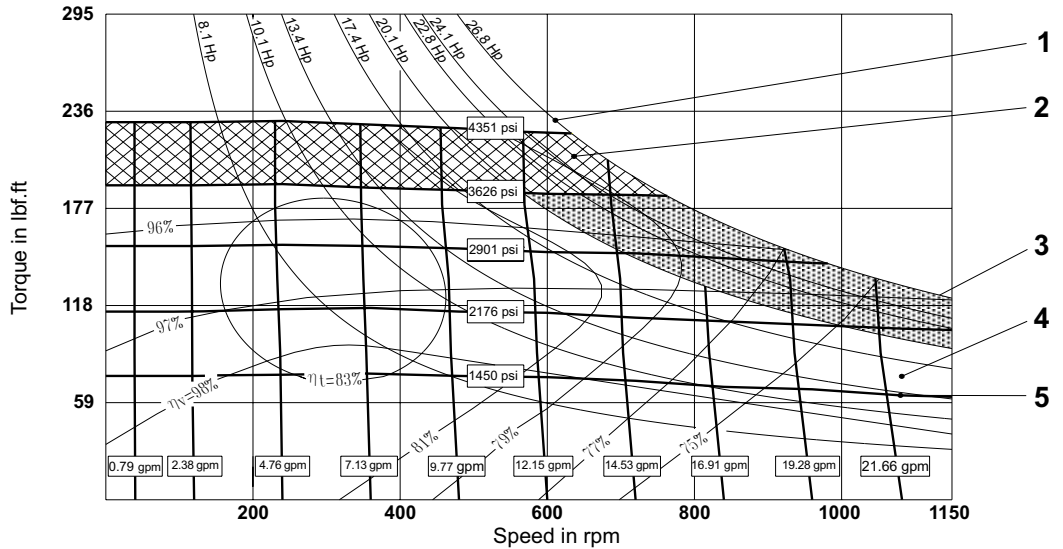



OPERATING DIAGRAM

(average values) measured at  $V = 167 \text{ SUS}$  ( $36 \text{ mm}^2/\text{s}$ );  $t = 113^\circ\text{F}$  ( $45^\circ\text{C}$ );

$p_{\text{outlet}} = 0 \text{ psi}$  (0 bar)

- 1 Output power
- 2 Intermittent operating area
- 3 Continuous operating area with flushing
- 4 Continuous operating area
- 5 Inlet pressure
- $\eta_t$  Total efficiency
- $\eta_v$  Volumeter efficiency

MR 93

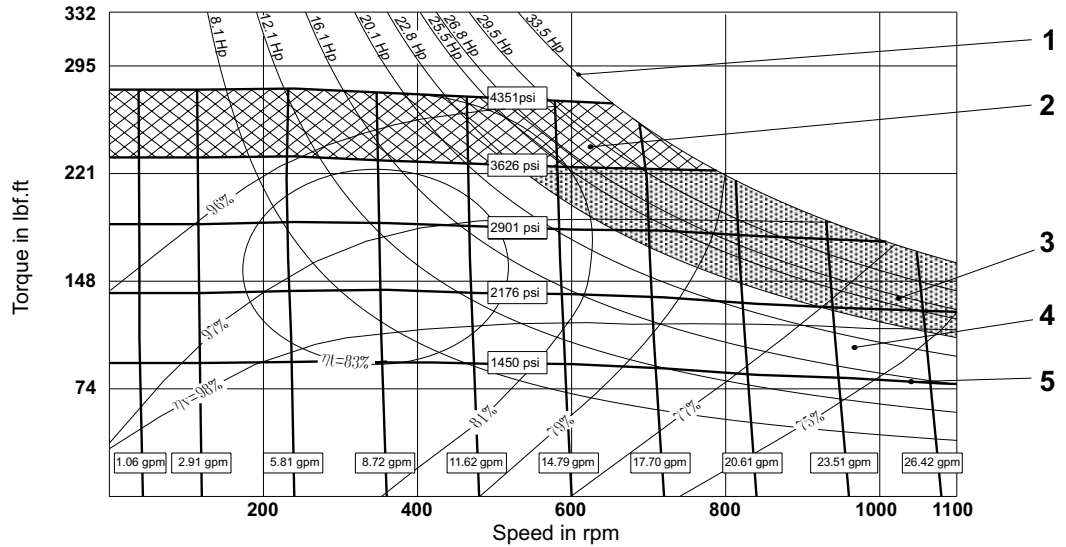

MR 110

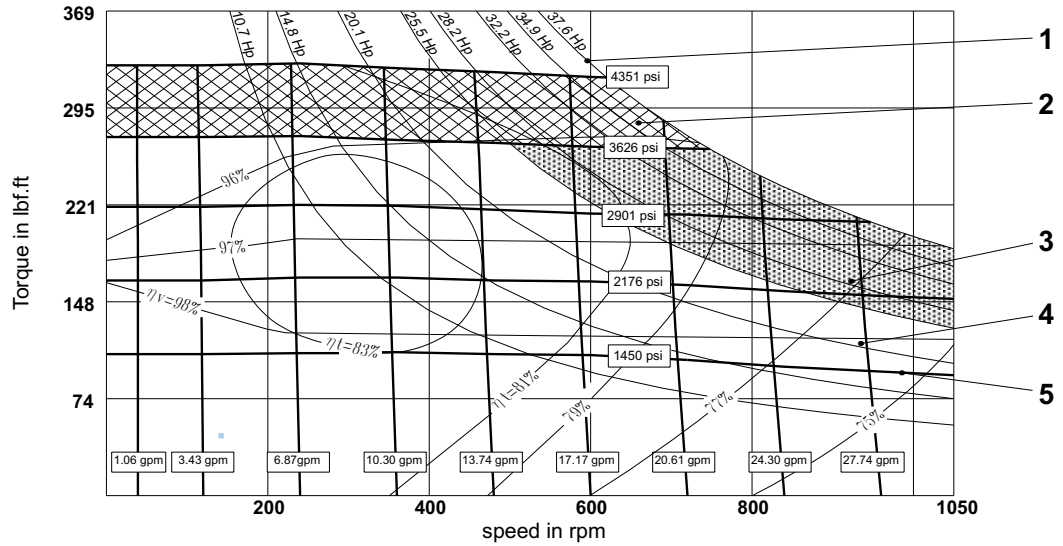

MR 125

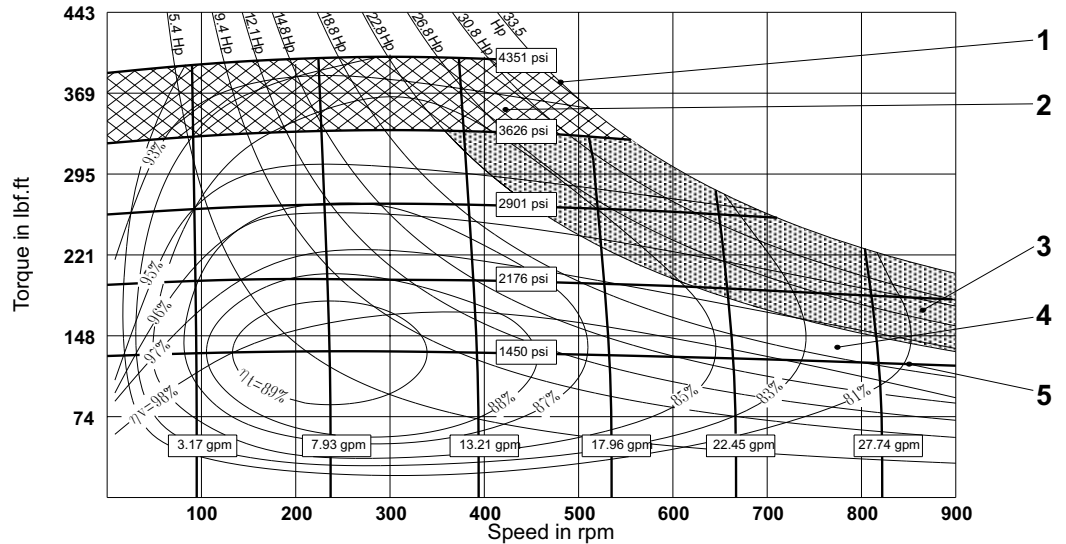

OPERATING DIAGRAM

(average values) measured at  $V = 167 \text{ SUS}$  ( $36 \text{ mm}^2/\text{s}$ );  $t = 113^\circ\text{F}$  ( $45^\circ\text{C}$ );

$p_{\text{outlet}} = 0 \text{ psi}$  (0 bar)

- 1 Output power
- 2 Intermittent operating area
- 3 Continuous operating area with flushing
- 4 Continuous operating area
- 5 Inlet pressure
- $\eta_t$  Total efficiency
- $\eta_v$  Volumeter efficiency

MR 160

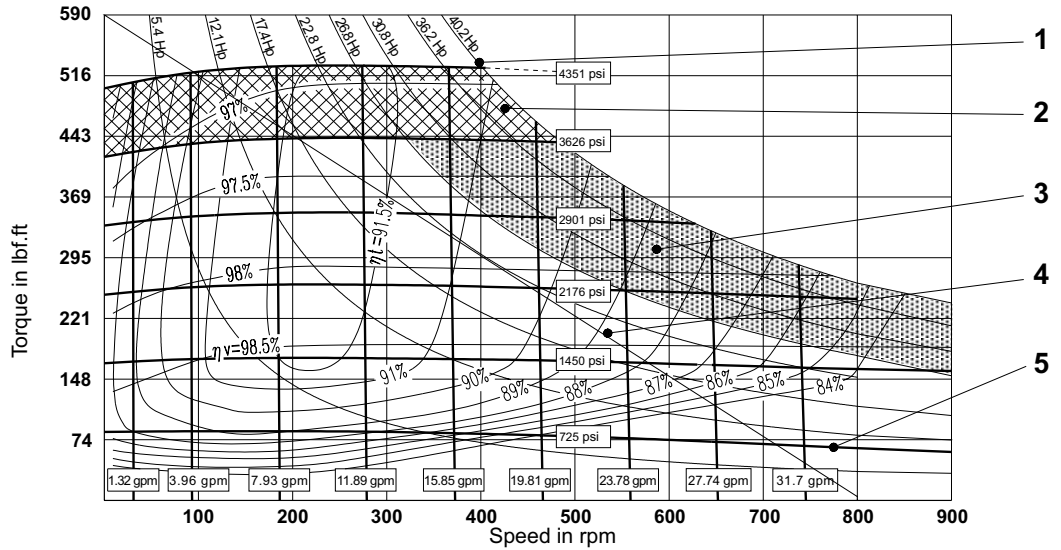

MR 190

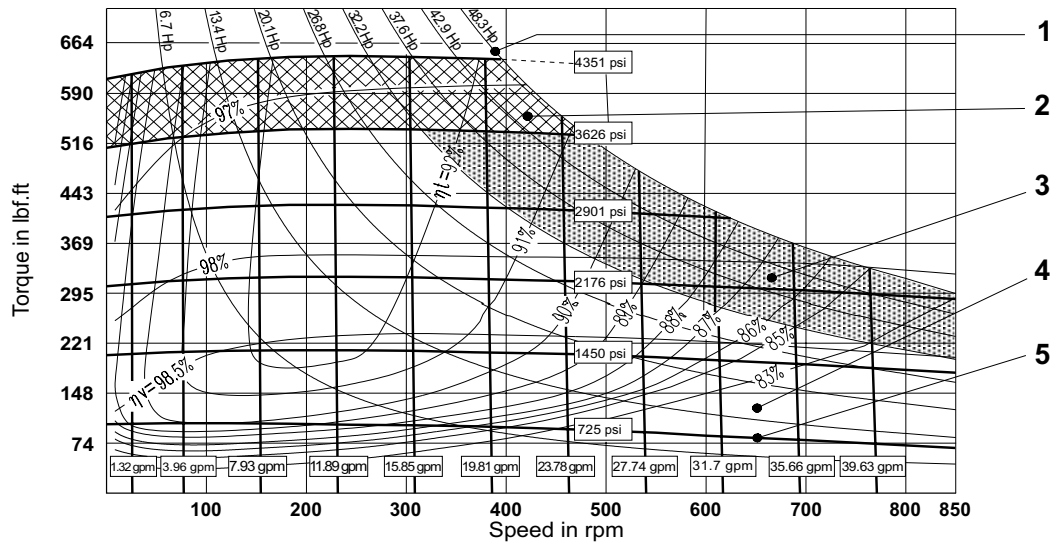

MR 200

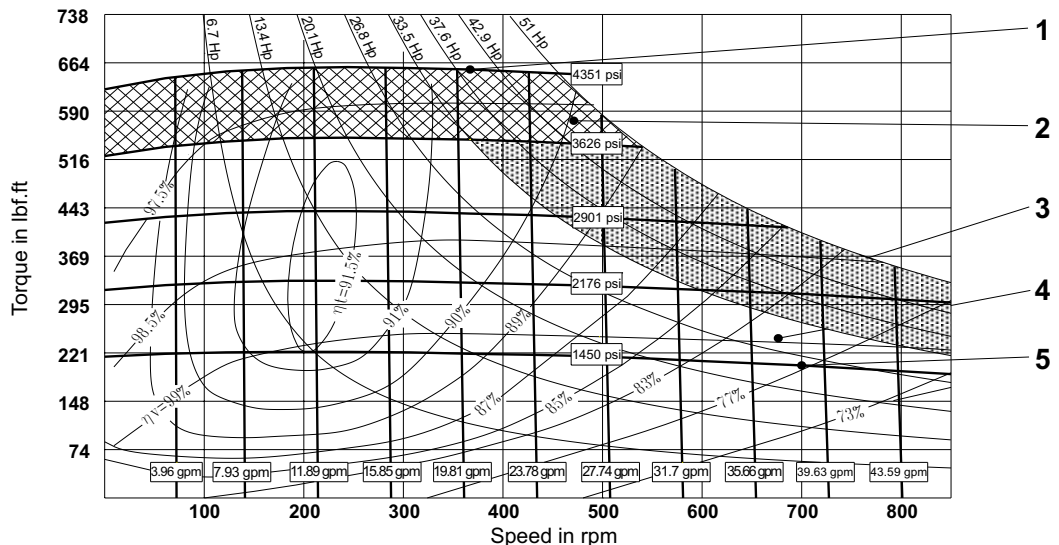

OPERATING DIAGRAM

(average values) measured at  $V = 167 \text{ SUS}$  ( $36 \text{ mm}^2/\text{s}$ );  $t = 113^\circ\text{F}$  ( $45^\circ\text{C}$ );

$p_{\text{outlet}} = 0 \text{ psi}$  (0 bar)

- 1 Output power
- 2 Intermittent operating area
- 3 Continuous operating area with flushing
- 4 Continuous operating area
- 5 Inlet pressure
- $\eta_t$  Total efficiency
- $\eta_v$  Volumeter efficiency

MR 250

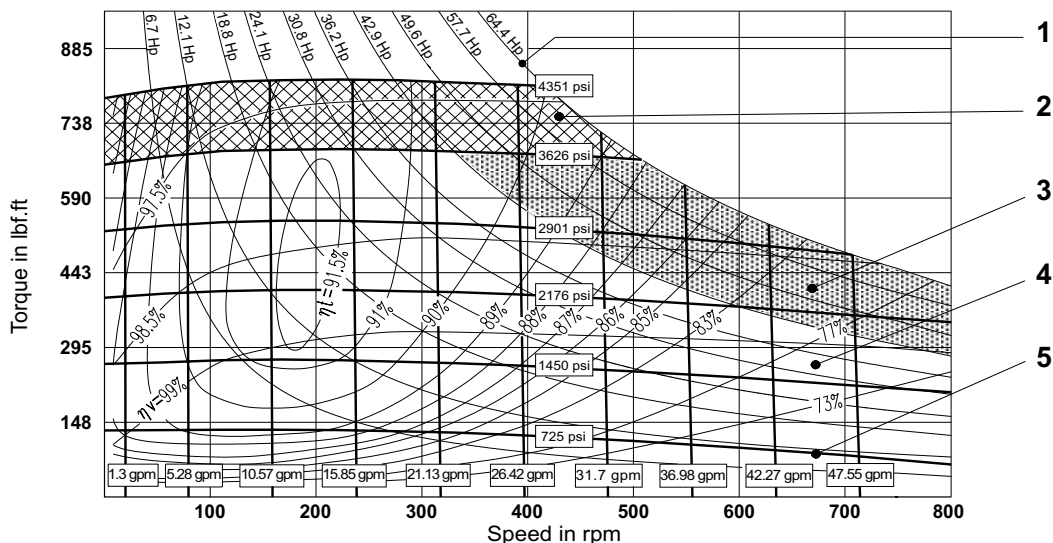

MR 300

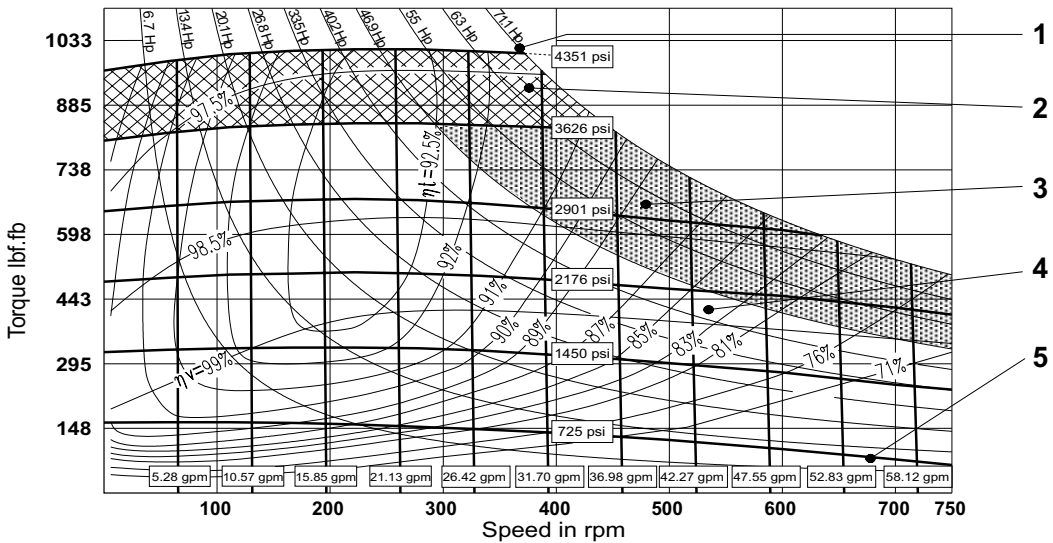

MRE 330

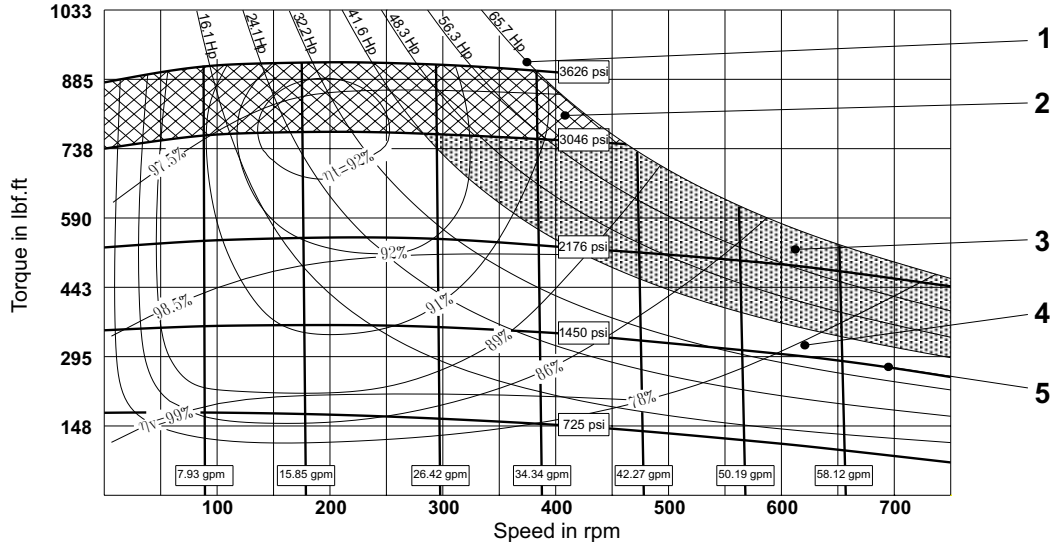

# OPERATING DIAGRAM - MOTOR TYPE MR - MRE

## OPERATING DIAGRAM

(average values) measured at  $V = 167 \text{ SUS}$  ( $36 \text{ mm}^2/\text{s}$ );  $t = 113^\circ\text{F}$  ( $45^\circ\text{C}$ );

$p_{\text{outlet}} = 0 \text{ psi}$  (0 bar)

- 1 Output power
- 2 Intermittent operating area
- 3 Continuous operating area with flushing
- 4 Continuous operating area
- 5 Inlet pressure
- $\eta_t$  Total efficiency
- $\eta_v$  Volumeter efficiency

### MR 350

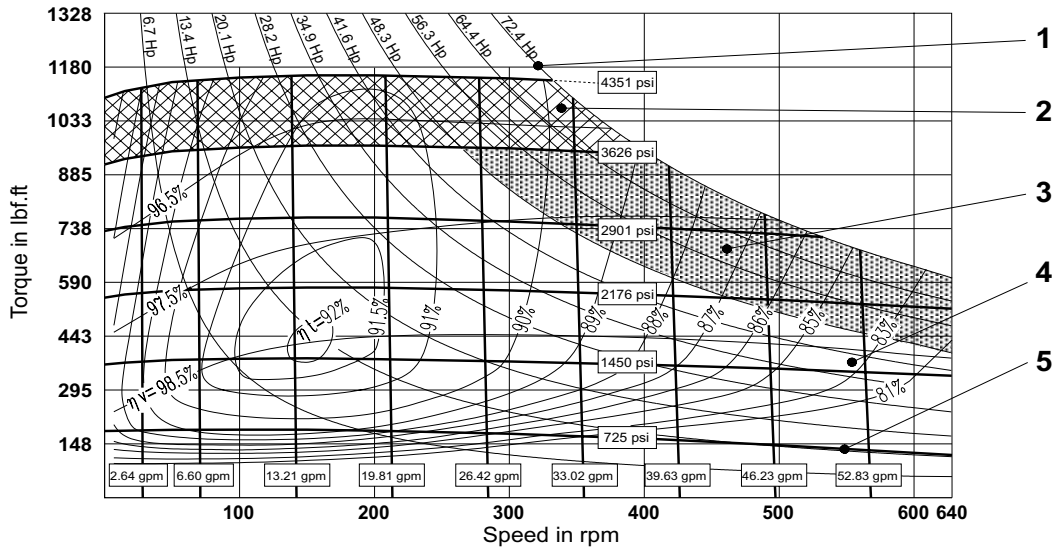

### MR 450

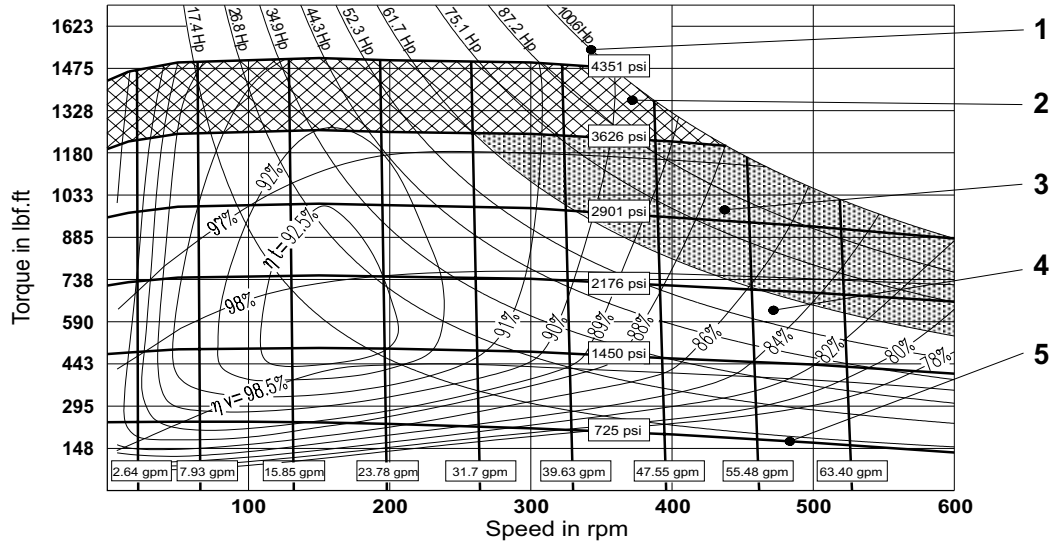

### MRE 500

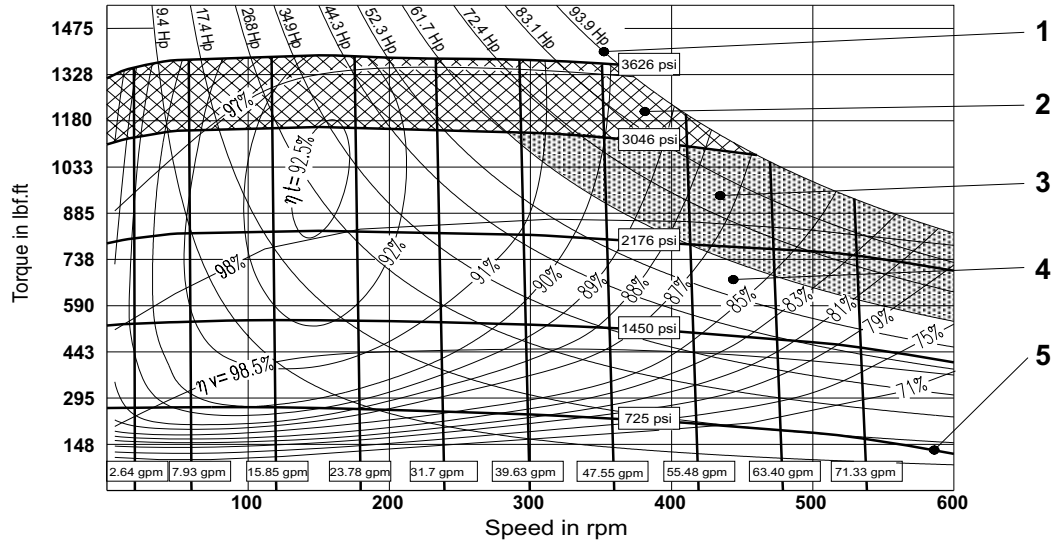

OPERATING DIAGRAM

(average values) measured at  $V = 167 \text{ SUS}$  ( $36 \text{ mm}^2/\text{s}$ );  $t = 113^\circ\text{F}$  ( $45^\circ\text{C}$ );

$p_{\text{outlet}} = 0 \text{ psi}$  (0 bar)

- 1 Output power
- 2 Intermittent operating area
- 3 Continuous operating area with flushing
- 4 Continuous operating area
- 5 Inlet pressure
- $\eta_t$  Total efficiency
- $\eta_v$  Volumeter efficiency

MR 600

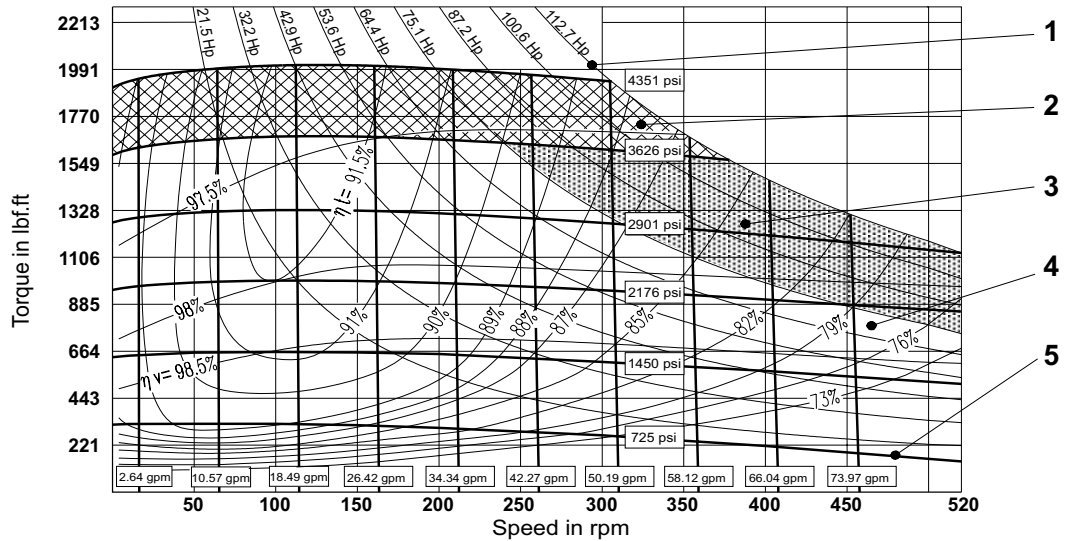

MR 700

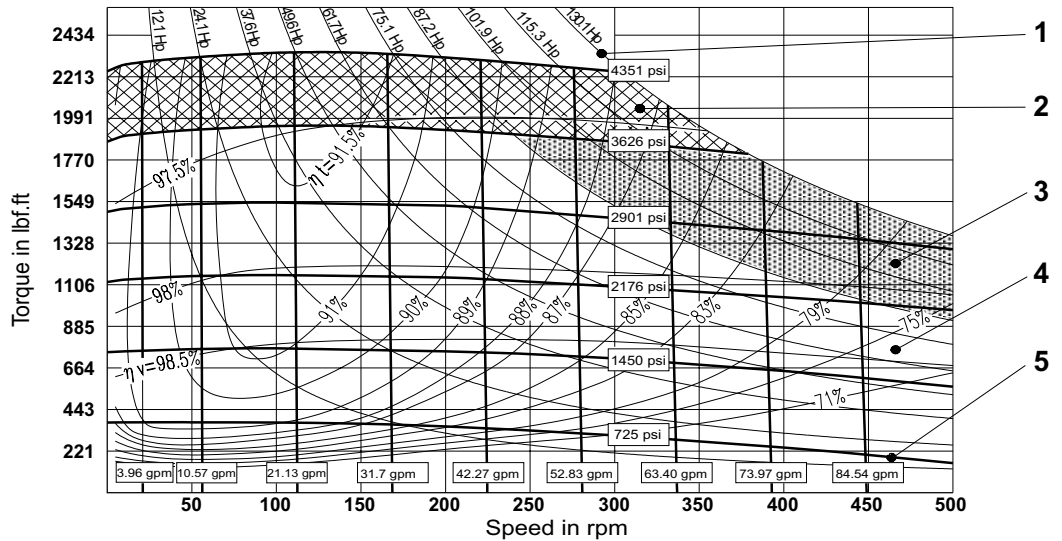

MRE 800

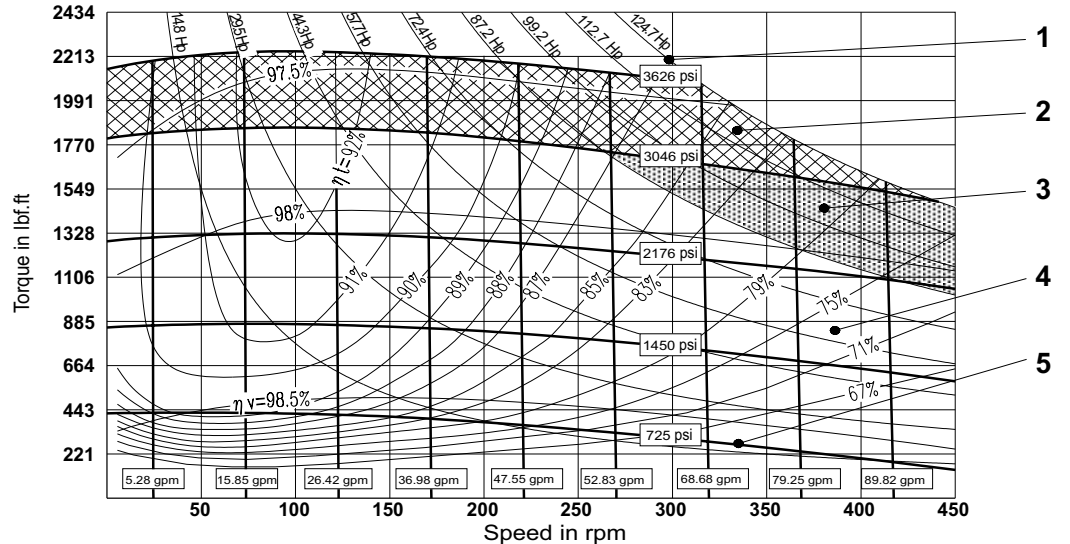

# OPERATING DIAGRAM - MOTOR TYPE MR - MRE

## OPERATING DIAGRAM

(average values) measured at  $V = 167 \text{ SUS}$  ( $36 \text{ mm}^2/\text{s}$ );  $t = 113^\circ\text{F}$  ( $45^\circ\text{C}$ );

$p_{\text{outlet}} = 0 \text{ psi}$  (0 bar)

- 1 Output power
- 2 Intermittent operating area
- 3 Continuous operating area with flushing
- 4 Continuous operating area
- 5 Inlet pressure
- $\eta_t$  Total efficiency
- $\eta_v$  Volumeter efficiency

### MR 1100

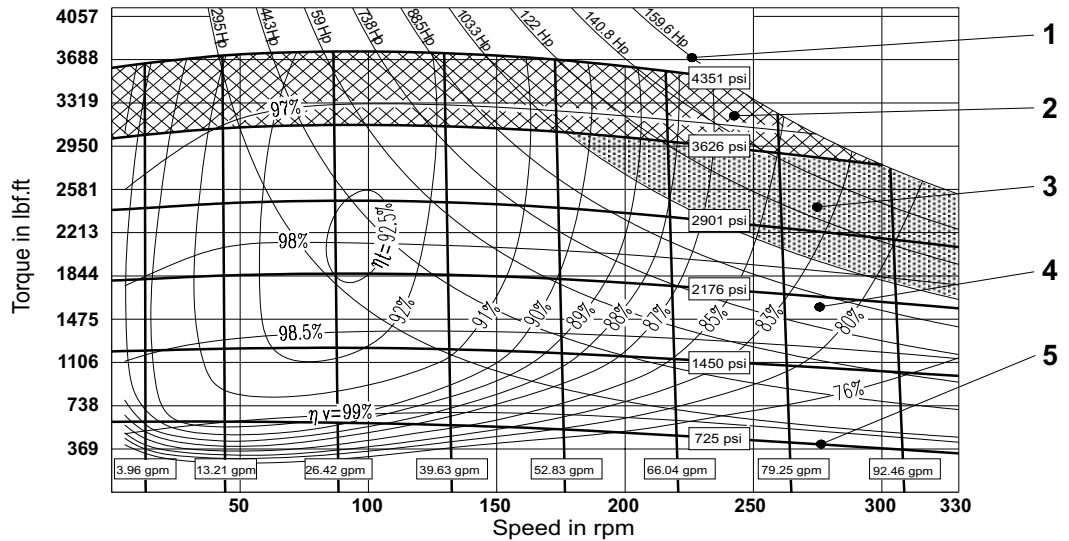

### MRE 1400

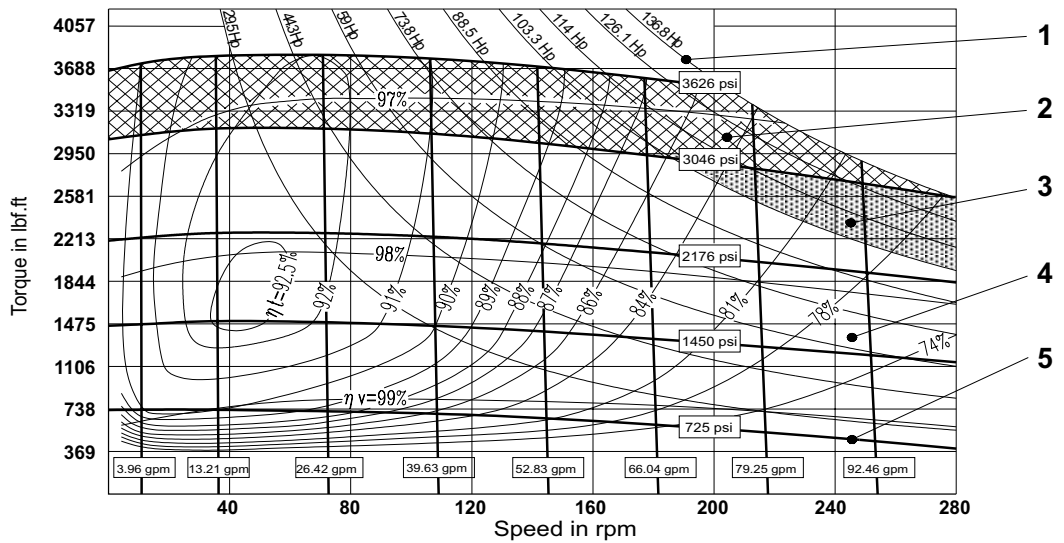

### MR 1600

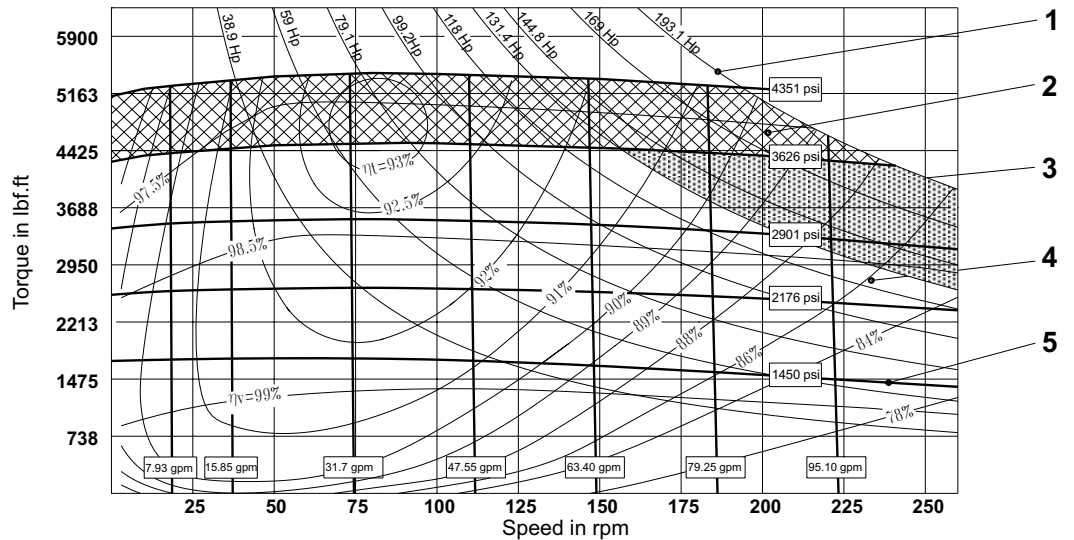

OPERATING DIAGRAM

(average values) measured at  $V = 167 \text{ SUS}$  ( $36 \text{ mm}^2/\text{s}$ );  $t = 113^\circ\text{F}$  ( $45^\circ\text{C}$ );

$\rho_{\text{outlet}} = 0 \text{ psi}$  (0 bar)

- 1 Output power
- 2 Intermittent operating area
- 3 Continuous operating area with flushing
- 4 Continuous operating area
- 5 Inlet pressure
- $\eta_t$  Total efficiency
- $\eta_v$  Volumeter efficiency

MR 1800

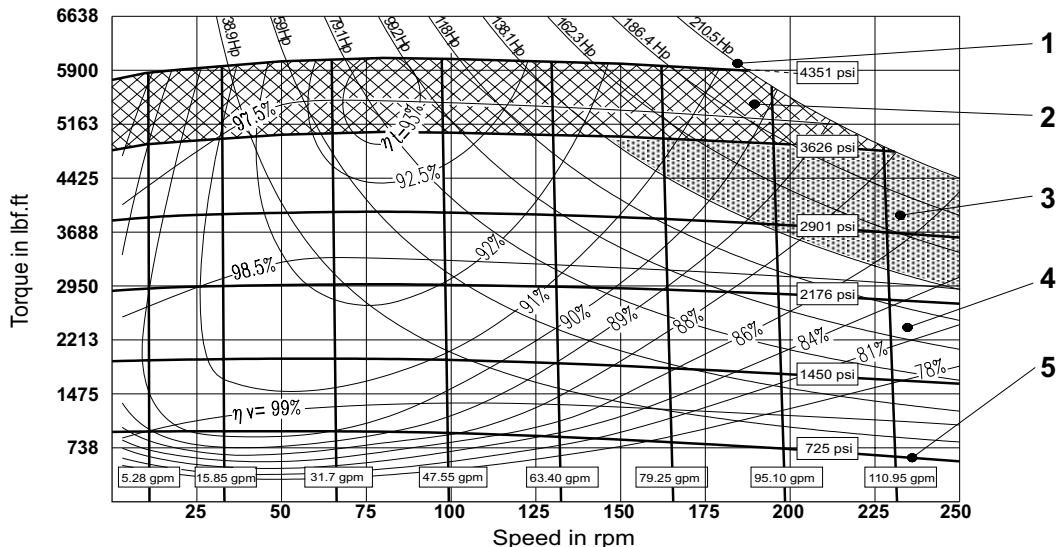

MRE 2100

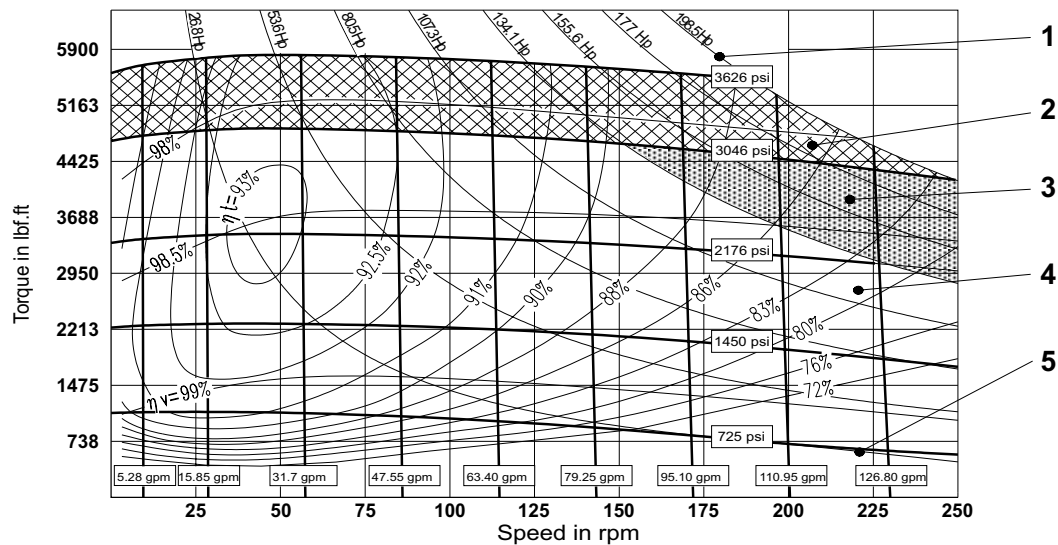

MR 2400

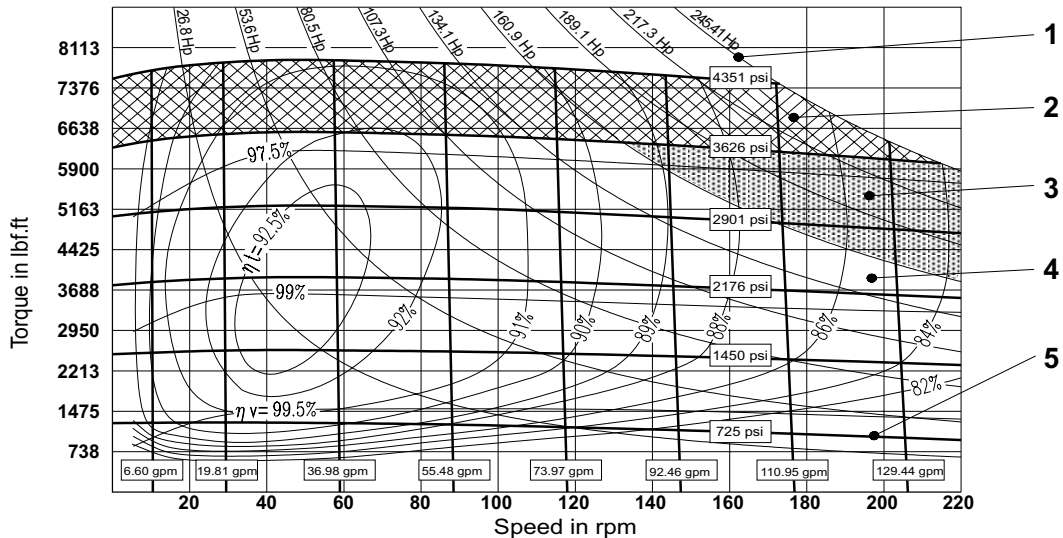

# OPERATING DIAGRAM - MOTOR TYPE MR - MRE

## OPERATING DIAGRAM

(average values) measured at  $V = 167 \text{ SUS}$  ( $36 \text{ mm}^2/\text{s}$ );  $t = 113^\circ\text{F}$  ( $45^\circ\text{C}$ );

$p_{\text{outlet}} = 0 \text{ psi}$  (0 bar)

- 1 Output power
- 2 Intermittent operating area
- 3 Continuous operating area with flushing
- 4 Continuous operating area
- 5 Inlet pressure
- $\eta_t$  Total efficiency
- $\eta_v$  Volumeter efficiency

### MR 2800

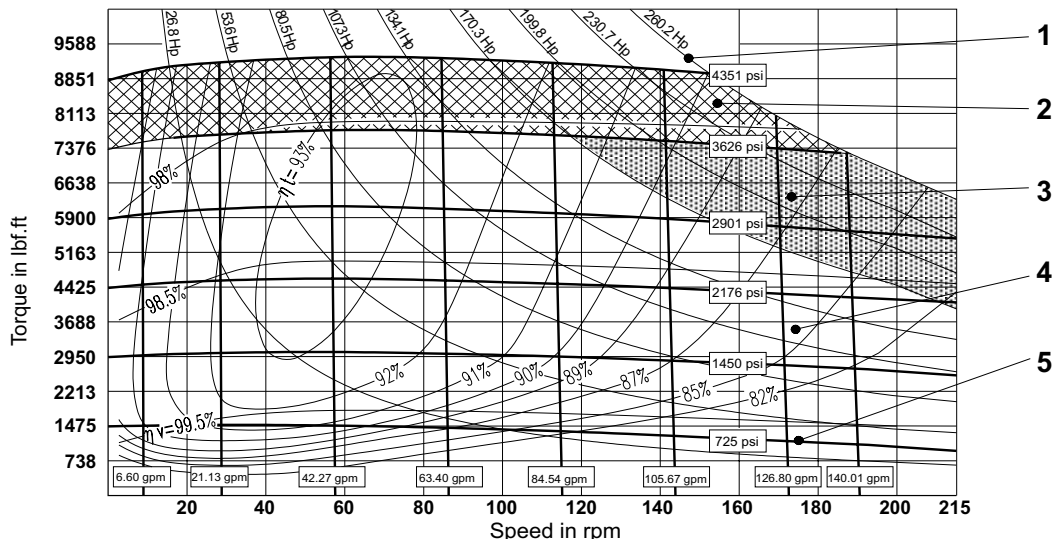

### MRE 3100

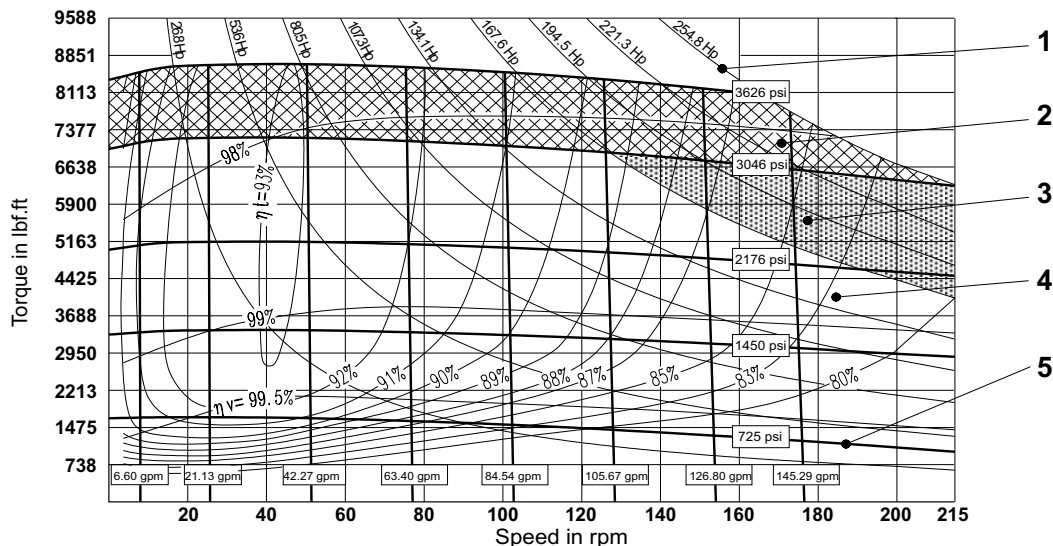

### MR 3600

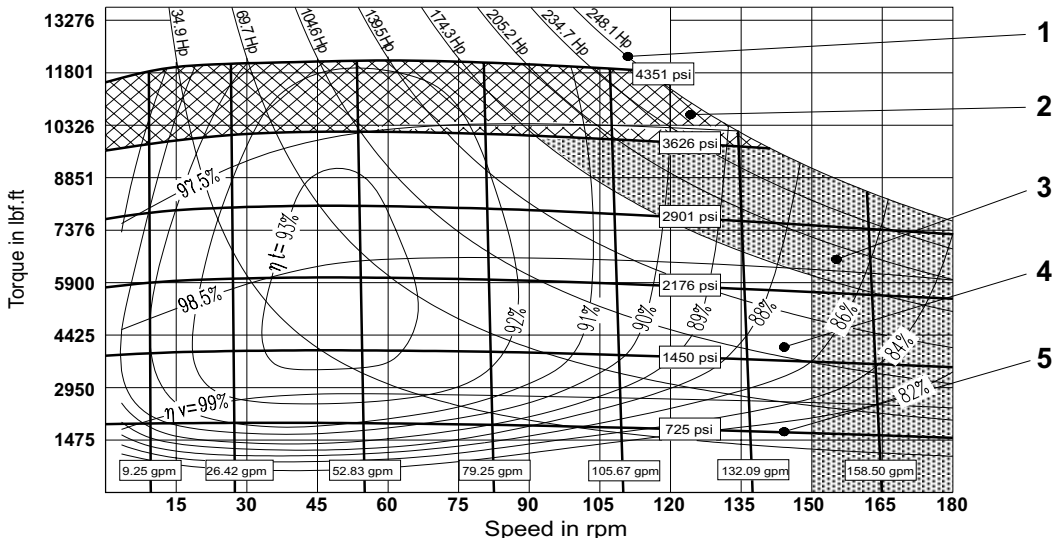



OPERATING DIAGRAM

(average values) measured at  $V = 167 \text{ SUS}$  ( $36 \text{ mm}^2/\text{s}$ );  $t = 113^\circ\text{F}$  ( $45^\circ\text{C}$ );

$p_{\text{outlet}} = 0 \text{ psi}$  (0 bar)

- 1 Output power
- 2 Intermittent operating area
- 3 Continuous operating area with flushing
- 4 Continuous operating area
- 5 Inlet pressure
- $\eta_t$  Total efficiency
- $\eta_v$  Volumeter efficiency

MR 4500

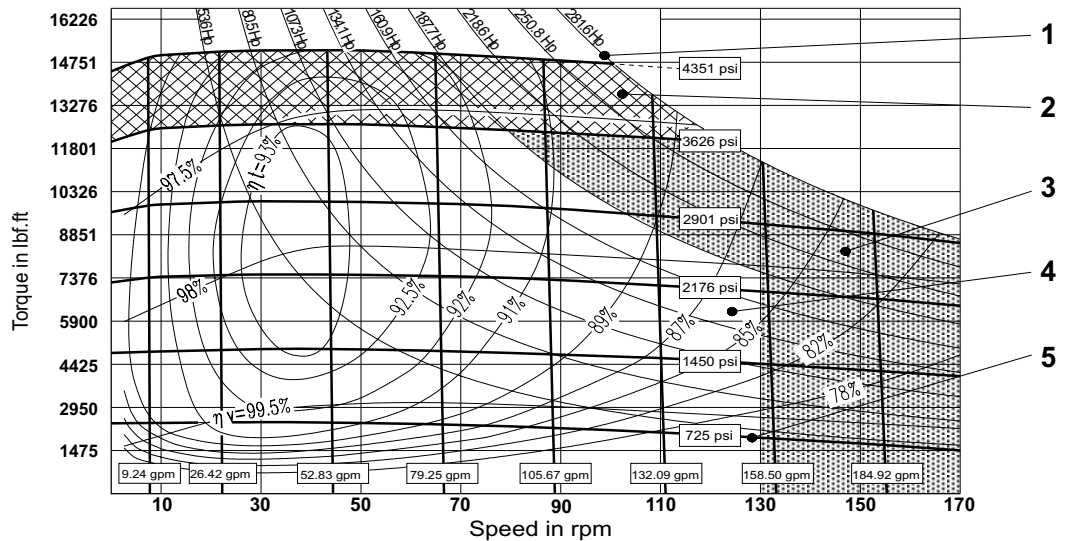

MRE 5400

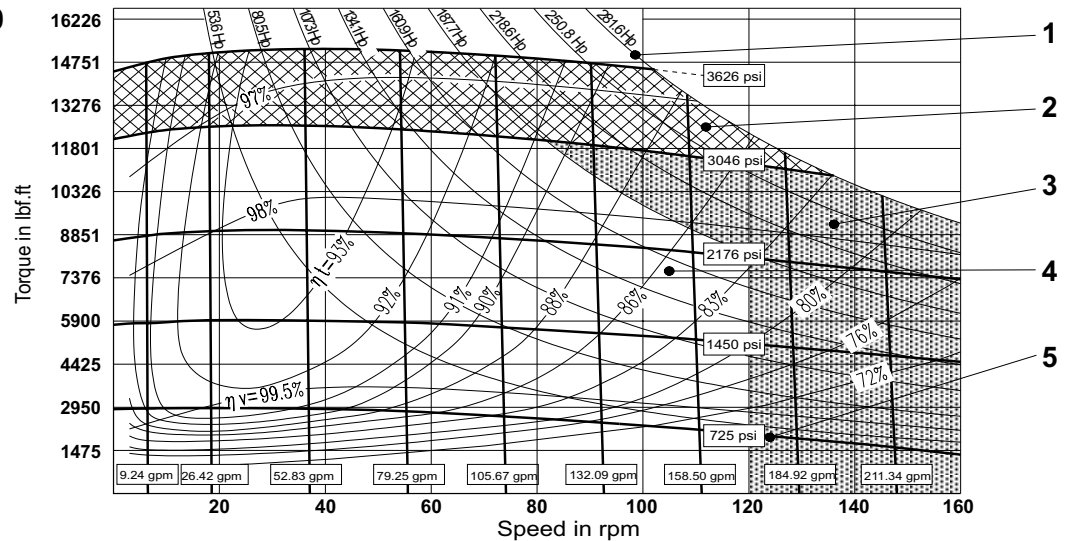

MR 6500

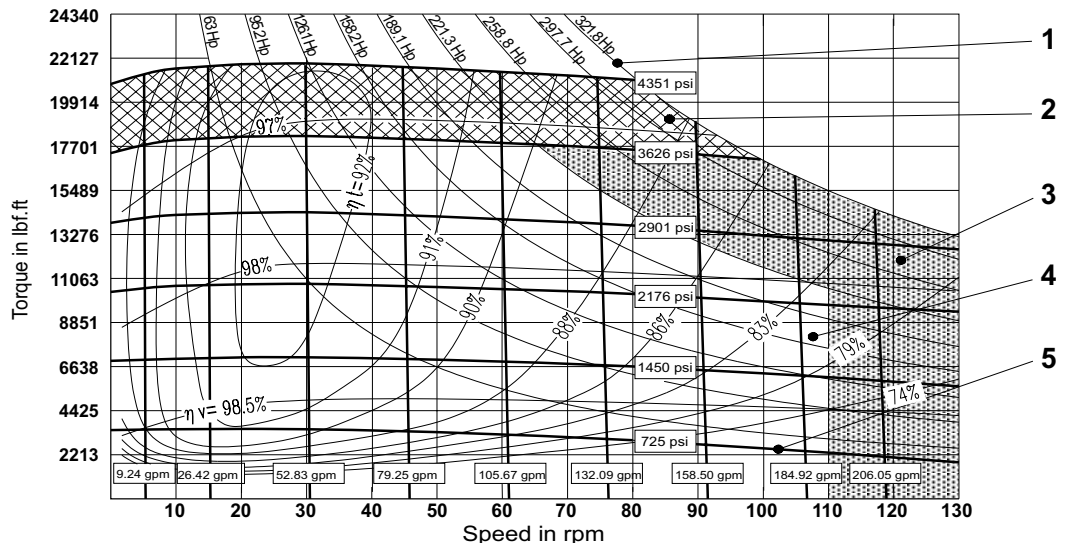

# OPERATING DIAGRAM - MOTOR TYPE MR - MRE

## OPERATING DIAGRAM

(average values) measured at  $V = 167 \text{ SUS}$  ( $36 \text{ mm}^2/\text{s}$ );  $t = 113^\circ\text{F}$  ( $45^\circ\text{C}$ );

$p_{\text{outlet}} = 0 \text{ psi}$  (0 bar)

- 1 Output power
- 2 Intermittent operating area
- 3 Continuous operating area with flushing
- 4 Continuous operating area
- 5 Inlet pressure
- $\eta_t$  Total efficiency
- $\eta_v$  Volumeter efficiency

### MR 7000

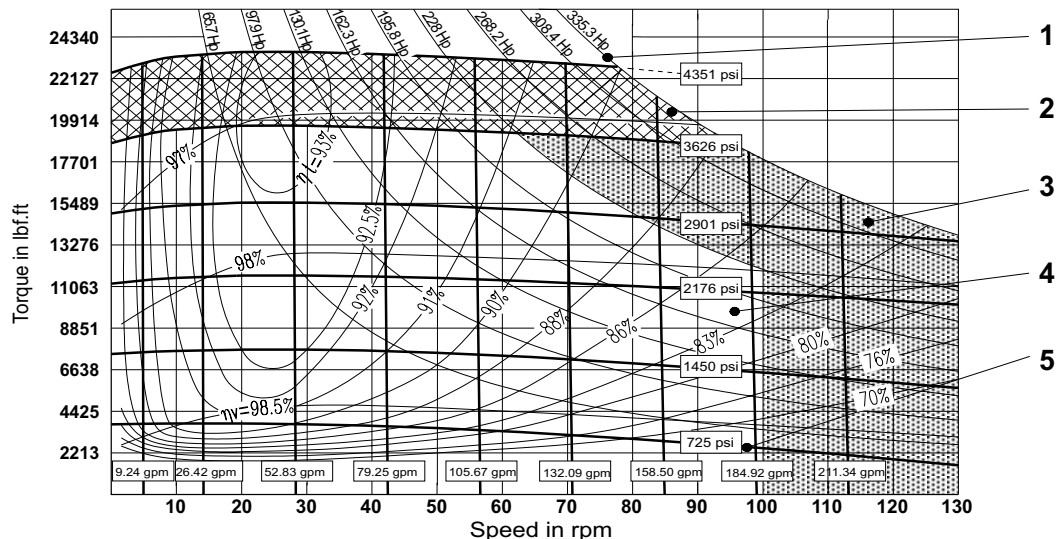

### MRE 8200

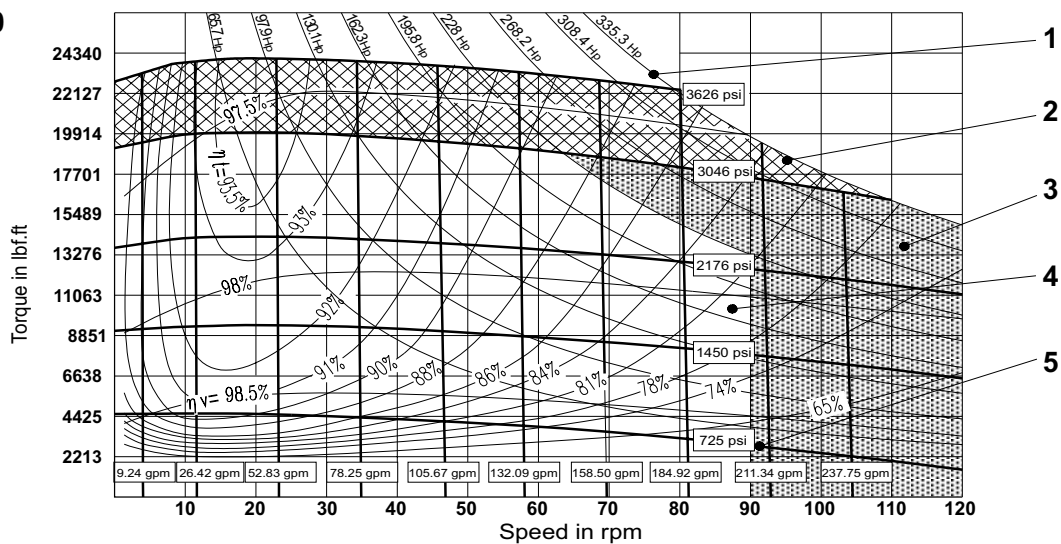

OPERATING DIAGRAM

(average values) measured at  $V = 167 \text{ SUS}$  ( $36 \text{ mm}^2/\text{s}$ );  $t = 113^\circ\text{F}$  ( $45^\circ\text{C}$ );

Min. required pressure difference  $\Delta p$  with idling speed (shaft unloaded)

$p_{\text{outlet}} = 0 \text{ psi}$  (0 bar)

**MR**  
**33 - 110**

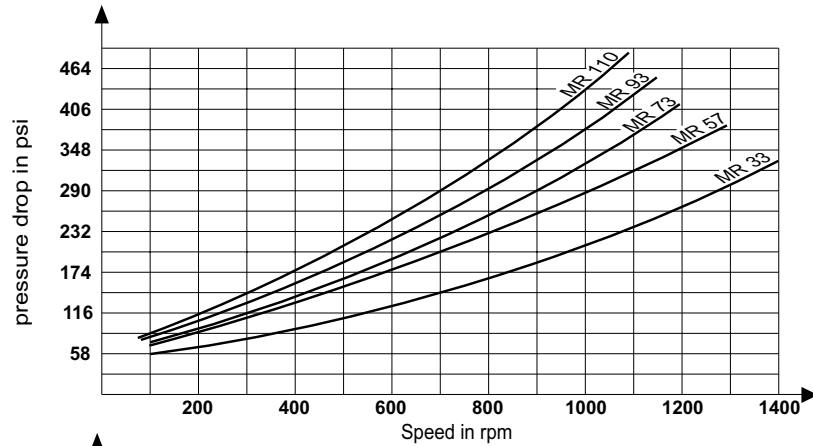

**MR - MRE**  
**125 - 330**

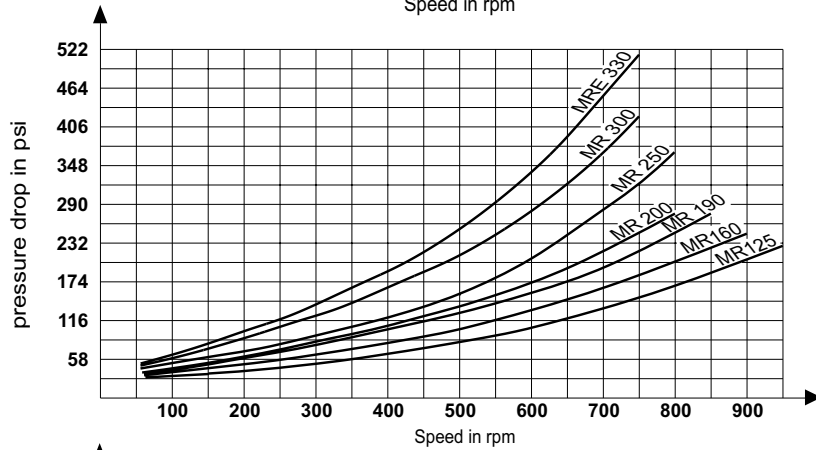

**MR - MRE**  
**350 - 800**

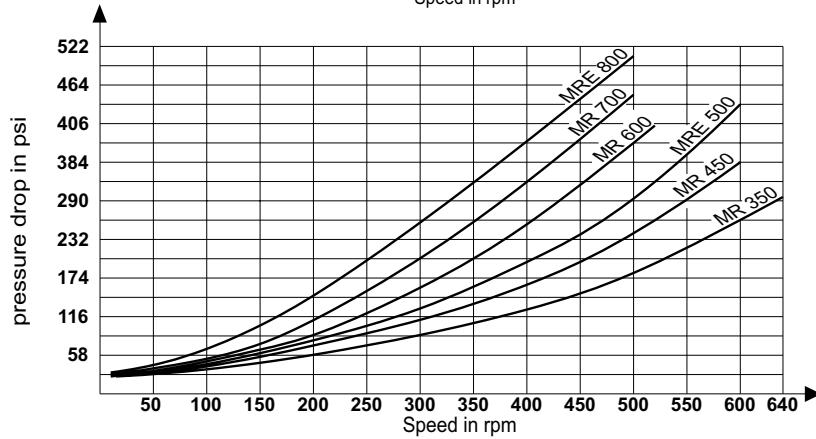

**MR - MRE**  
**1100 - 2100**

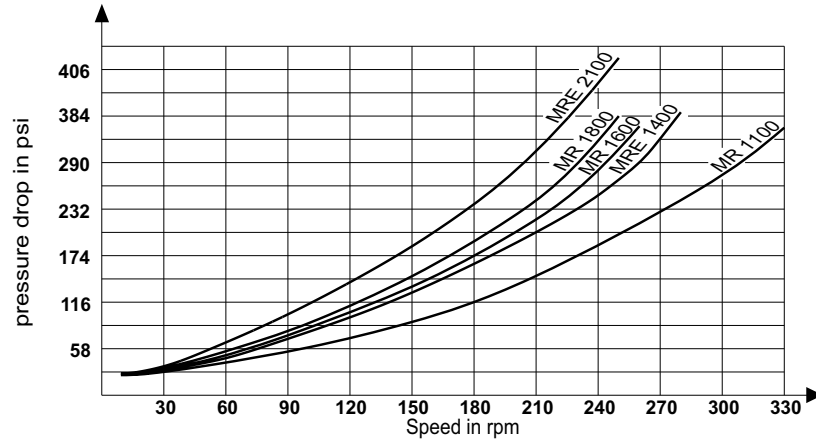

OPERATING DIAGRAM

(average values) measured at  $V = 167 \text{ SUS (36 mm}^2\text{/s)}$ ;  $t = 113^\circ\text{F (45}^\circ\text{C)}$ ;

Min. required pressure difference  $\Delta p$  with idling speed (shaft unloaded)

$p_{\text{outlet}} = 0 \text{ psi (0 bar)}$

**MR - MRE  
2400 - 8200**

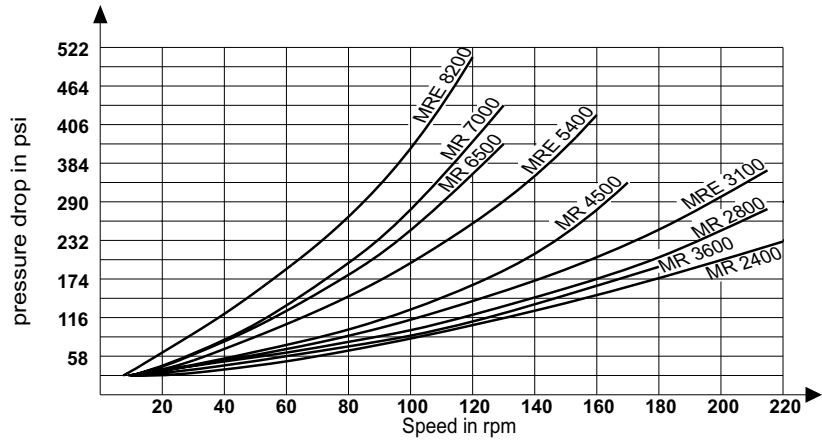

Minimum boost pressure during pump operation

**MR  
33 - 110**

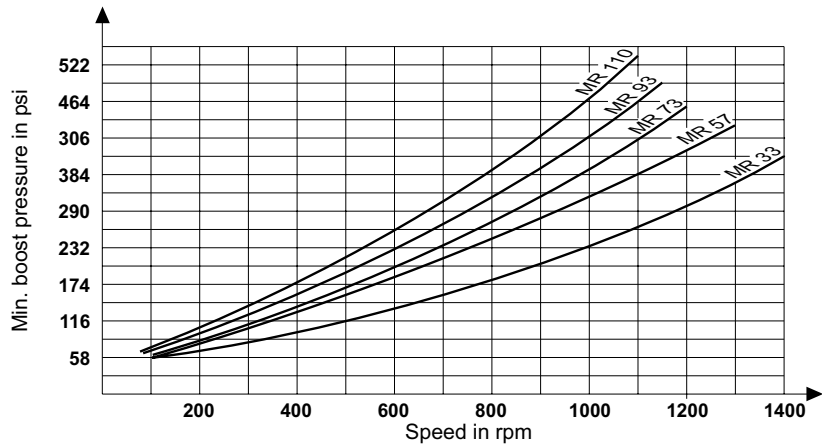

**MR - MRE  
125 - 330**

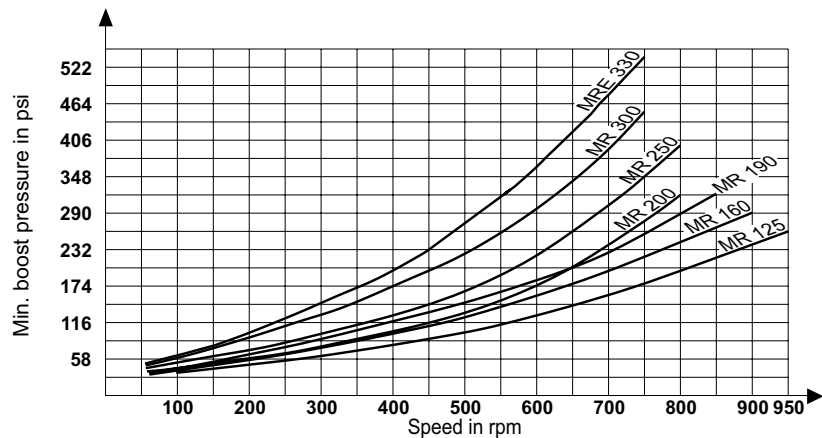

OPERATING DIAGRAM

(average values) measured at  $V = 167 \text{ SUS}$  ( $36 \text{ mm}^2/\text{s}$ );  $t = 113^\circ\text{F}$  ( $45^\circ\text{C}$ );

Minimum boost pressure during pump operation

$p_{\text{outlet}} = 0 \text{ psi}$  (0 bar)

**MR - MRE  
350 - 800**

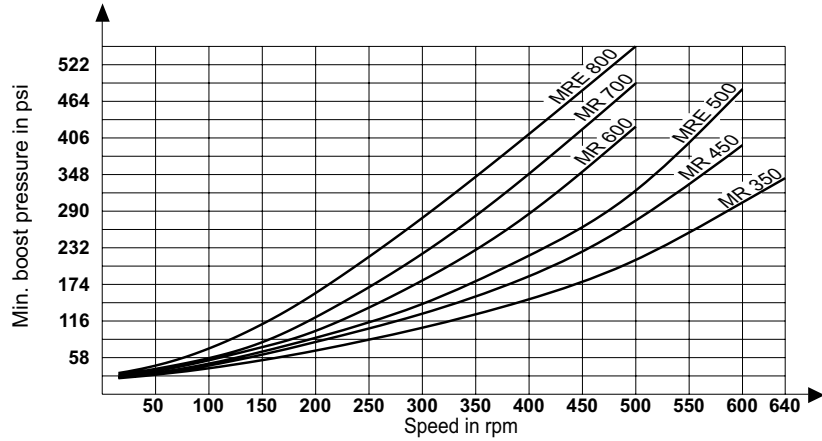

**MR - MRE  
1100 - 2100**

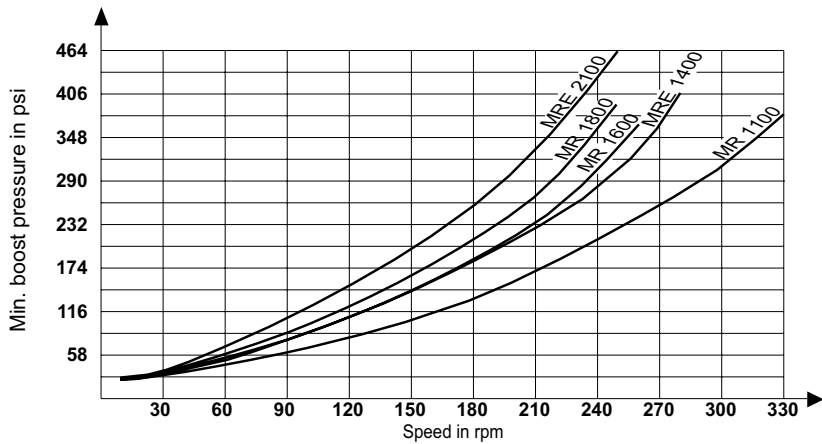

**MR - MRE  
2400 - 8200**

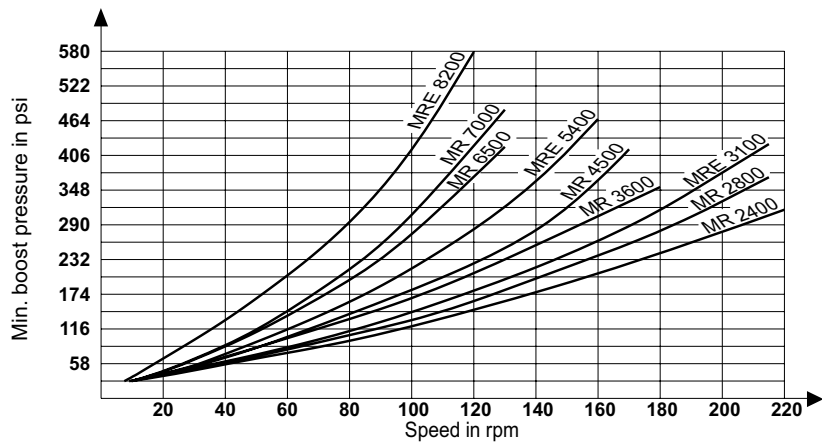

RADIAL LOAD

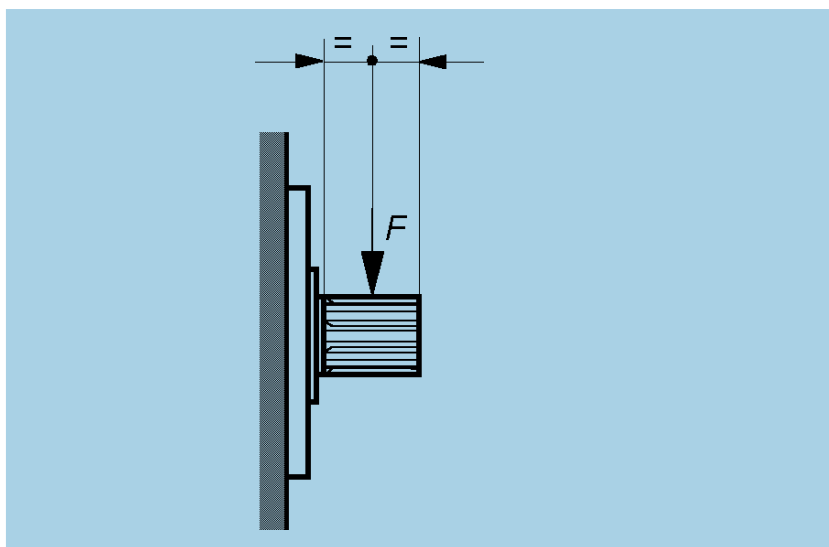

MOTOR TYPE	RADIAL FORCE <sup>MAX</sup> I BRIEFLY PERMITTED WITH DYNAMIC LOAD F in lbf <sup>1)</sup>	MAX. PERMITTED RADIAL FORCE IN SHAFT CENTRE BASED ON L <sub>H10</sub> 5000 HOURS			speed in rpm
		INPUT PRESSURE 2901 psi F in lbf	INPUT PRESSURE 2176 psi F in lbf	INPUT PRESSURE 1450 psi F in lbf	
MR 33	4271.37	2135.69	2293.05	2382.98	400
MR 57	4271.37	2135.69	2293.05	2382.98	400
MR 73	5058.20	2023.28	2607.78	3034.92	350
MR 93	5058.20	2023.28	2607.78	3034.92	350
MR 110	5058.20	2023.28	2607.78	3034.92	350
MR 125	5058.20	1124.05	2225.61	2900.04	275
MR 160	5058.20	1124.05	2225.61	2900.04	275
MR 190	5058.20	1124.05	2225.61	2900.04	275
MR 200 *	-	-	-	-	-
MR 250	6294.65	1258.93	2225.61	2832.59	250
MR 300	6294.65	1258.93	2225.61	2832.59	250
MR 350	7868.31	3259.73	4136.49	4765.95	225
MR 450	7868.31	3259.73	4136.49	4765.95	225
MR 600	9666.78	3372.13	5058.20	6137.28	200
MR 700	9666.78	3372.13	5058.20	6137.28	200
MR 1100	12139.7	4158.97	6407.06	7913.28	150
MR 1600	15287	5889.99	9127.24	11240.45	125
MR 1800	15287	5889.99	9127.24	11240.45	125
MR 2400	19108.76	11262.93	14837.39	17265.33	110
MR 2800	19108.76	12139.68	15511.82	17849.83	100
MR 3600	24279.37	12364.50	20232.8	23155.32	100
MR 4500	24279.37	17535.1	21806.47	24504.17	85
MR 6500	30124.4	16635.86	27651.5	31698.06	50
MR 7000	30124.4	16635.86	27651.5	31698.06	50
MRE 330	6294.65	1011.64	1910.88	2675.23	250
MRE 500	7868.31	2787.63	3889.20	4676.03	225
MRE 800	9666.78	1910.87	4451.22	5912.48	200
MRE 1400	12139.7	1933.35	5395.42	7553.58	140
MRE 2100	15287	2810.11	8003.20	10858.27	120
MRE 3100	19108.76	10116.4	14500.18	17445.17	100
MRE 5400	24279.37	14162.96	20277.77	24122	80
MRE 8200	30124.4	15287.01	24728.98	28775.54	50

<sup>1)</sup> in accordance with the dynamic condition, higher values can be accepted - MR 200\* only code "F1"

BEARING LIFE

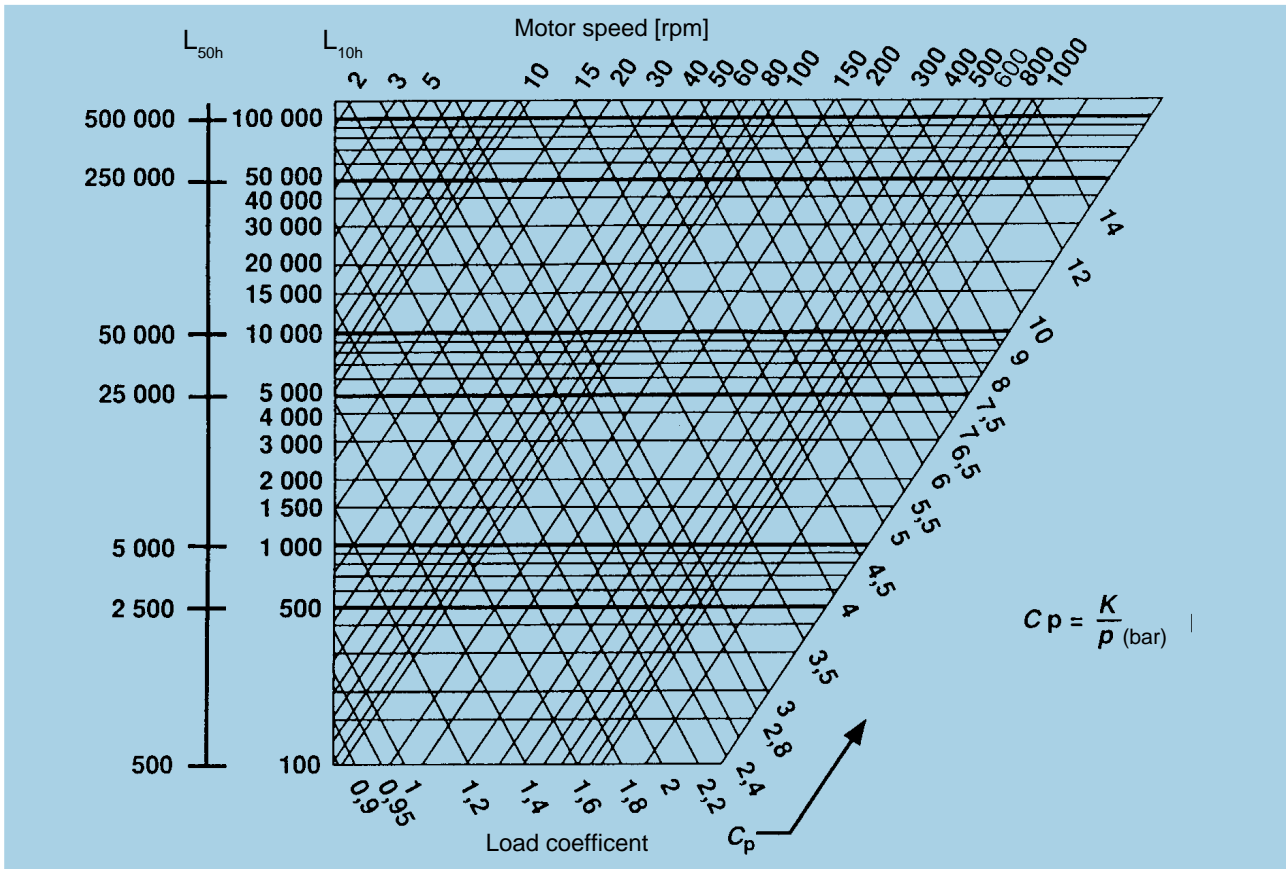

$C_p$  = Load coefficient  
 $K$  = Service life coefficient for standard bearing  
 $p$  = operating pressure in bar  
 Convert pressure 1psi = 0.0690 bar

$L_{10h}$  is the theoretically service life value normally reached or exceeded by the 90% of the bearings.

50 % of the bearings reach the value  $L_{50h} = 5$  times  $L_{10h}$ .

MOTOR TYPE	K	MOTOR TYPE	K	MOTOR TYPE	K
MR 33	2150	MRE 330	850	MRE 2100	722
MR 57	2150	MR 350	1126	MR 2400	924
MR 73	1320	MR 450	1126	MR 2800	924
MR 93	1320	MRE 500	1021	MRE 3100	828
MR 110	1320	MR 600	920	MR 3600	709
MR 125	950	MR 700	920	MR 4500	709
MR 160	950	MRE 800	808	MRE 5400	591
MR 190	950	MR 1100	844	MR 6500	710
MR 200	950	MRE 1400	693	MR 7000	710
MR 250	950	MR 1600	835	MRE 8200	550
MR 300	950	MR 1800	835		

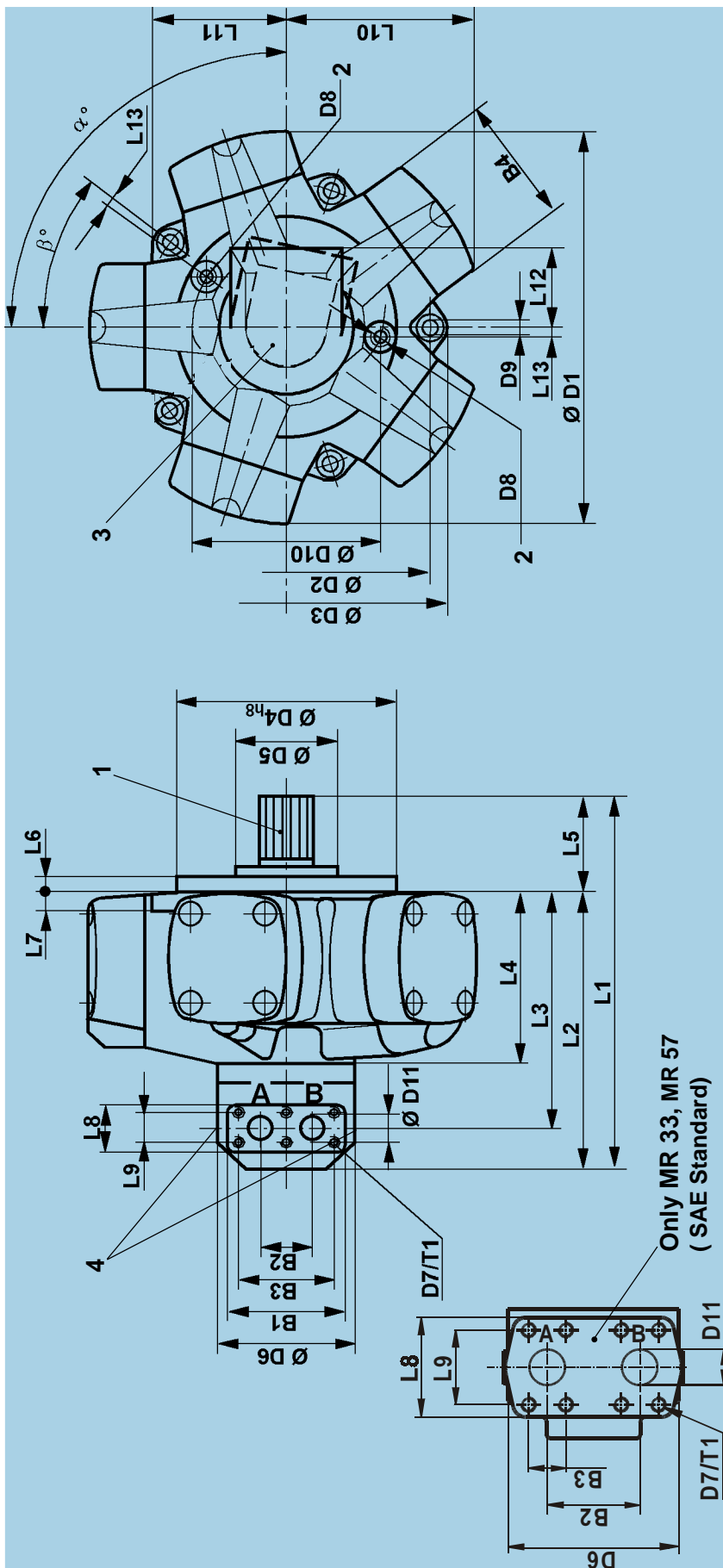

Only MR 33, MR 57  
( SAE Standard)

- 1 Splined shaft with flank contact (for dimension see page 26) Ordering code "N1" (for further shaft ends see page 26 - 27)
- 2 Case drain port BSP threads to ISO 228/1

- 3 On request the port flange can be rotated by 72° (For MR 33, MR 57, MR 73, MR 93, MR 110, MR 125, MR 160, MR 190, MR 200, MR 250, MR 300, MRE 330, MR 350, MR 450, MRE 500, MR 600, MR 700, MRE 800 can be rotated by 36°) For standard position see angle  $\alpha$ .
- 4 Port 1/4" BSP threads to ISO 228/1 for pressure reading.

Dir. of Rotation (Viewed on shaft end)	Port inlet	ordering code (see page 35)
clockwise	A	"N"
anti-clockwise	B	"S"
clockwise	B	"S"
anti-clockwise	A	"N"



MOTOR DIMENSIONS - MOTOR TYPE MR - MRE

MOTOR TYPE	L1 (in)	L2 (in)	L3 (in)	L4 (in)	L5 (in)	L6 (in)	L7 (in)	L8 (in)	L9 (in)	L10 (in)	L11 (in)	L12 (in)	L13 (in)	B1 (in)	B2 (in)	B3 (in)	B4 (in)	Ø D1 (in)	Ø D2 (in)	Ø D3 (in)	Ø D4 <sup>16</sup> (in)	Ø D5 (in)	Ø D6 (in)	D7 (mm)	T1 (in)	D8 (in)	D9 (in)	Ø D10 (in)	Ø D11 (in)	α	β
<b>MR 33</b> <b>MR 57</b>	9.97	7.72	5.83	4.21	2.25	0.55	0.75	2.76	2.06	4.34	3.09	2.76	0.78	4.88	2.56	1.03	2.73	9.27	6.3	7.09	4.9212 4.9188 (125 mm)	-	4.72	M10	0.98	G1/4	0.35	3.82	0.98	108°	36°
<b>MR 73</b> <b>MR 93</b> <b>MR 110</b>	11.69	9.00	7.50	5.18	2.70	0.67	0.79	2.13	1.34	4.72	3.70	2.84	-	4.72	1.97	3.94	3.54	9.84	8.03	8.84	5.7086 5.7062 (145 mm)	-	5.08	M8	0.59	G3/8	0.43	-	0.79	90°	36°
<b>MR 125</b> <b>MR 160</b> <b>MR 190</b>	12.17	9.53	8.03	5.71	2.64	0.55	0.63	2.13	1.34	5.81	4.06	2.84	0.26	4.72	1.97	3.94	3.94	12.33	8.86	9.80	6.2991 6.2967 (160 mm)	-	5.08	M8	0.59	G 3/8	0.43	6.30	0.79	90°	36°
<b>MR 200</b> <b>MR 250</b> <b>MR 300</b> <b>MRE 330</b>	12.72	9.53	8.03	5.71	3.19	0.59	0.63	2.13	1.34	6.04	4.69	2.84	0.30	4.72	1.97	3.94	3.94	12.91	9.13	10.08	6.8897 6.8873 (175 mm)	3.54	5.08	M8	0.59	G 3/8	0.43	6.38	0.79	90°	36°
<b>MR 350</b> <b>MR 450</b> <b>MRE 500</b>	14.8	10.98	9.25	6.57	3.82	0.59	0.71	2.77	1.57	6.87	5.12	3.31	0.37	5.59	2.36	4.72	4.69	14.49	10.47	11.65	7.4802 7.4775 (190 mm)	3.78	6.14	M10	0.71	G 3/8	0.51	7.64	0.98	90°	36°
<b>MR 600</b> <b>MR 700</b> <b>MRE 800</b>	15.75	11.77	10.04	7.36	3.98	0.59	0.79	2.77	1.57	7.56	5.63	3.31	0.31	5.59	2.36	4.72	5.24	15.95	11.42	12.60	8.6614 8.6586 (220 mm)	4.02	6.14	M10	0.71	G 3/8	0.51	8.15	0.98	90°	36°
<b>MR 1100</b> <b>MRE 1400</b>	18.03	13.43	11.54	7.99	4.61	0.79	0.87	3.23	1.97	8.78	6.50	4.13	0.35	6.38	2.87	5.35	5.83	18.50	12.99	14.45	9.8425 9.8397 (250 mm)	4.72	6.77	M12	0.83	G 1/2	0.59	8.98	1.22	104°	36°
<b>MR 1600</b> <b>MR 1800</b> <b>MRE 2100</b>	19.92	14.72	12.83	9.29	5.20	0.83	0.94	3.23	1.97	10.39	7.76	4.13	0.43	6.38	2.87	5.35	6.61	21.97	14.96	16.65	11.4173 11.4141 (290 mm)	5.83	6.77	M12	0.83	G 1/2	0.67	10.47	1.22	90°	36°
<b>MR 2400</b> <b>MR 2800</b> <b>MRE 3100</b>	24.37	18.35	15.43	11.22	6.02	0.94	1.02	3.86	2.44	11.93	8.70	4.84	0.59	8.19	3.39	7.09	7.48	25.28	17.32	19.45	13.1889 13.1854 (335 mm)	5.51	8.46	M14	1.10	G 1/2	0.75	12.36	1.46	90°	36°
<b>MR 3600</b> <b>MR 4500</b> <b>MRE 5400</b>	27.54	19.27	16.48	12.11	8.27	1.34	1.10	3.86	2.68	14.15	9.72	5.51	0.75	9.06	4.57	7.87	9.45	30.16	21.26	23.50	15.7479 15.7457 (400 mm) * D4 <sup>17</sup>	-	8.46	M16	1.26	G 1/2	0.91	14.96	1.50	108°	36°
<b>MR 6500</b> <b>MR 7000</b> <b>MRE 8200</b>	31.34	22.28	19.49	15.12	9.06	1.46	1.18	3.86	2.68	16.04	9.72	5.51	0.83	9.06	4.57	7.87	10.39	34.02	23.62	25.93	17.7165 17.714 (450 mm) * D4 <sup>17</sup>	7.48	8.46	M16	1.25	G 1/2	0.98	17.72	1.50	108°	36°

Code D 1 - DIN 5480 - (Standard)

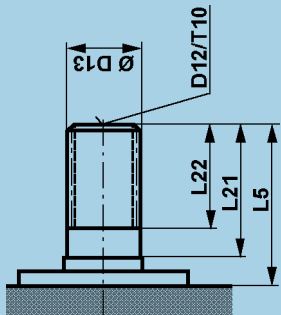

Code B 1 - BS 3550 - ( )

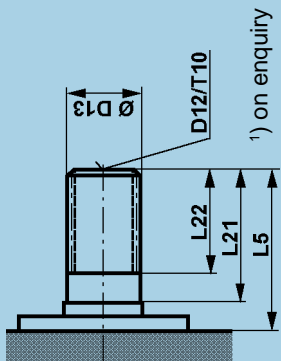

Code N 1 (Standard)

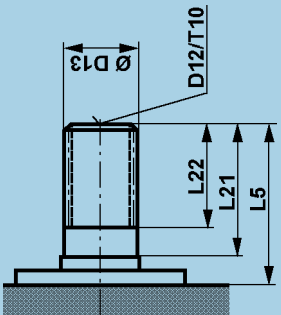

Type	Version	N1					B1					D1							
		L5 (in)	L21 (in)	L22 (in)	D12 (mm)	T10 (in)	ØD13 ex DIN 5463 (mm)	L5 (in)	L21 (in)	L22 (in)	D12 (mm)	T10 (in)	ØD13 BS 3550	L5 (in)	L21 (in)	L22 (in)	D12 (mm)	T10 (in)	ØD13 DIN 5480 (mm)
MR 33		2.24	1.57	1.10	-	-	-	-	-	-	-	-	-	2.24	1.57	1.10	-	-	W32x1.5x20-8e
MR 57		2.70	2.03	1.24	M12	-	-	-	-	-	-	-	2.70	2.03	1.24	M12	-	-	W35x2x16-8e
MR 73		2.64	1.97	1.40	M12	0.79	2.64	1.97	1.40	M12	0.79	12/24-17	2.64	1.97	1.40	M12	0.79	0.79	W38x2x18-8e
MR 93		-	-	-	-	-	-	-	-	-	-	-	-	-	-	-	-	-	-
MR 110		3.19	2.36	1.81	M12	0.98	3.19	2.36	1.77	M12	0.98	12/24+21	3.19	2.36	1.81	M12	0.98	0.98	W48x2x22-8e
MR 125		3.82	2.91	2.22	M12	0.98	3.82	2.91	2.40	M12	0.98	8/16-17	3.82	2.91	2.36	M12	0.98	0.98	W55x3x17-8e
MR 160		3.98	3.07	2.44	M12	0.98	3.98	3.07	2.44	M12	0.98	8/16-17	3.98	3.07	2.44	M12	0.98	0.98	W60x3x18-8e
MR 190		4.61	3.46	2.72	M12	0.98	4.61	3.46	2.64	M12	0.98	6/12-14	4.61	3.46	2.83	M12	0.98	0.98	W70x3x22-8e
MR 200 *		5.20	3.94	3.11	M12	0.98	5.20	3.94	2.99	M12	0.98	6/12-20	5.20	3.94	3.15	M12	0.98	0.98	W80x3x25-8e
MR 250		6.02	4.72	3.90	M12	0.98	6.02	4.72	2.99	M12	0.98	6/12-20	6.02	4.72	3.94	M12	0.98	0.98	W90x4x21-8e
MR 300		8.27	6.81	5.67	M12	0.98	8.27	6.81	5.61	M12	0.98	6/12-20	8.27	6.81	5.67	M12	0.98	0.98	W110x4x26-8e
MR 350		9.06	7.40	5.91	M12	0.98	9.06	7.40	6.02	M12	0.98	6/12-26	9.06	7.40	6.02	M12	0.98	0.98	W120x4x28-8e
MRE 330																			
MR 450																			
MRE 450																			
MR 500																			
MRE 500																			
MR 600																			
MRE 600																			
MR 700																			
MRE 700																			
MR 800																			
MRE 800																			
MR 1100																			
MRE 1400																			
MR 1600																			
MR 1800																			
MRE 2100																			
MR 2400																			
MR 2800																			
MRE 3100																			
MR 3600																			
MR 4500																			
MRE 5400																			
MR 6500																			
MR 7000																			
MRE 8200																			

NOTE: the threaded holes (D12/T10) for the shaft versions "N1", "B1" and "D1" must be considered as service holes. In case the holes dimensions required by the application are different from the ones listed here above, please contact DENISON Calzoni.  
MR\_200 \* only code "F1"

Code F 1 - DIN 5480 -

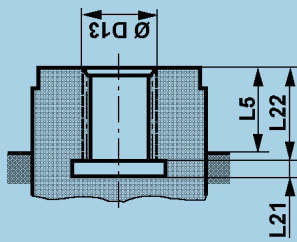

Code P 1

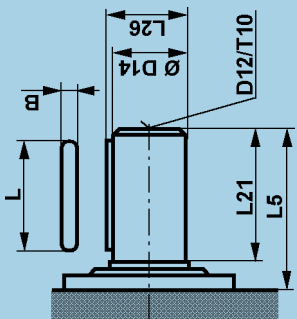

Code P 1 \*\*\*

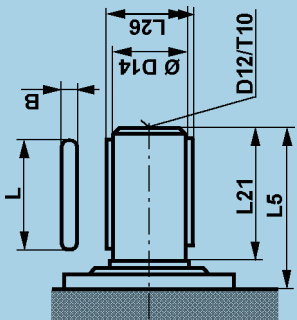

Only MR 6500, MR 7000, MRE 8200

Version	F					P							Transmitted torque (lbf.ft)
	L5 (in)	L21 (in)	L22 (in)	Ø D13 DIN 5480 (mm)	L5 (in)	L21 (in)	L26 (in)	D12 (mm)	T10 (in)	Ø D14 <sup>**</sup> (in)	Key (mm) L x B		
MR 33	0.67	0.20	0.83	N28x1,25x21-9H	-	-	-	-	-	-	-	-	-
MR 57	0.67	0.20	1.02	N32x2x14-9H	-	-	-	-	-	-	-	-	-
MR 73	0.55	0.20	1.10	N35x2x16-9H	2.64	1.97	1.69	M12	0.79	1.5755 1.5749 (40 mm)	45 x 12	366	
MR 125	1.06	0.20	1.42	N40x2x18-9H	-	-	-	-	-	-	-	-	-
MR 200 *	1.06	0.20	1.42	N40x2x18-9H	3.19	2.36	2.11	M12	0.98	1.9692 1.9686 (50 mm)	56 x 14	662	
MR 250	1.10	0.20	1.50	N47x2x22-9H	3.82	2.91	2.32	M12	0.98	2.1661 2.1655 (55 mm)	70 x 16	1042	
MR 300	1.10	0.20	1.73	N55x3x17-9H	3.98	3.07	2.52	M12	0.98	2.3630 2.3623 (60 mm)	70 x 18	1498	
MR 350	1.50	0.31	1.97	N65x3x20-9H	4.61	3.46	3.01	M12	0.98	2.7567 2.7560 (70 mm)	80 x 20	1984	
MR 450	1.85	0.31	2.24	N75x3x24-9H	5.20	3.94	3.35	M12	0.98	3.1504 3.1497 (80 mm)	90 x 22	2965	
MR 500	1.89	0.31	2.44	N85x3x27-9H	6.02	4.72	3.74	M12	0.98	3.5442 3.5434 (90 mm)	110 x 25	4578	
MR 600	1.97	0.55	2.68	N100x3x32-9H	8.27	6.81	4.57	M12	0.98	4.3316 4.3308 (110 mm)	160 x 28	7934	
MR 700	1.97	0.55	2.99	N110x3x35-9H	9.06	7.40	5.43 ***	M12	0.98	4.8716 4.8691 (124 mm)	N°2-180 x 32	20850	

**NOTE**  
For higher values of the torque to be transmitted, please consult DENISON Calzoni

NOTE: the threaded holes (D12/T10) for the shaft versions "P1" must be considered as service holes. In case the holes dimensions required by the application are different from the ones listed here above, please contact DENISON Calzoni.

\*\* ØD14<sub>hg</sub> for MR 6500, MR 7000, MRE 8200

\*\*\* This dimension includes two keys

MECHANICAL  
TACHOMETER DRIVE

TACHOGENERATOR  
DRIVE

ENCODER  
DRIVE

Dimensions in inch (threaded holes in mm)

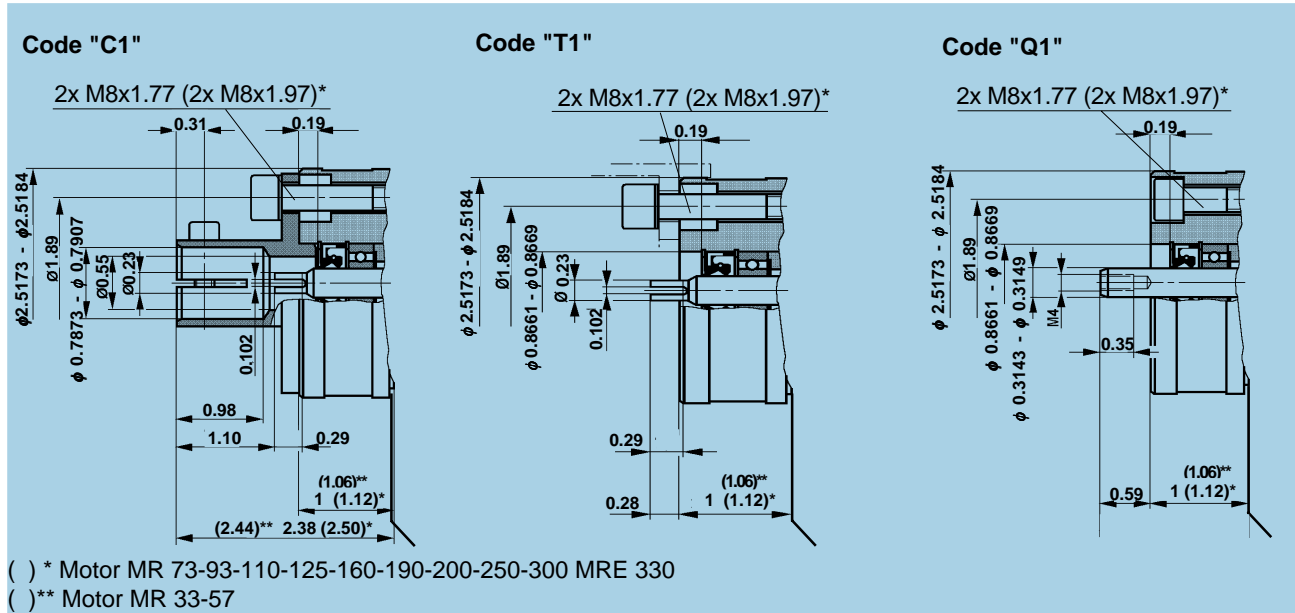

INCREMENTAL ENCODER  
DIMENSIONS

Dimensions in inch (in)

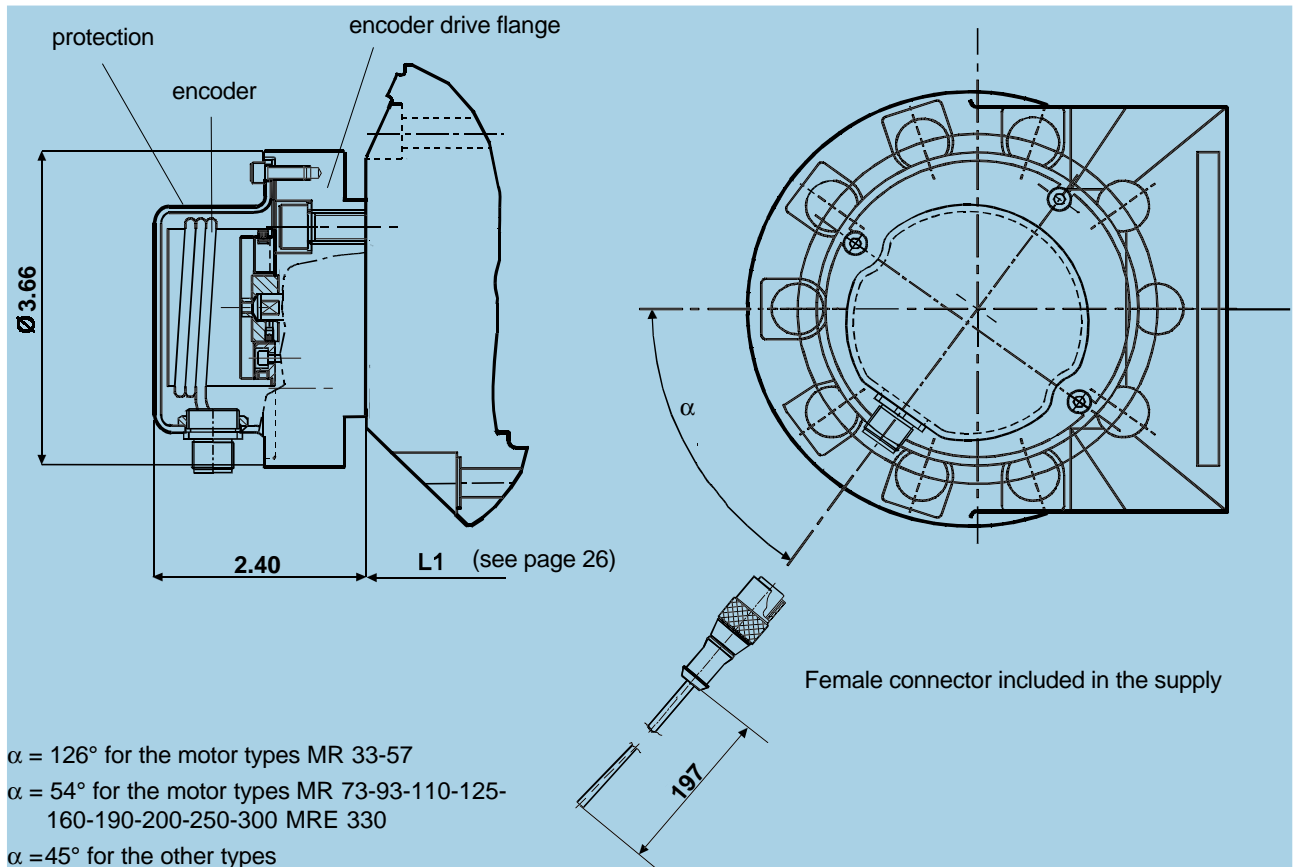

**INCREMENTAL ENCODER  
CONNECTION DIAGRAMS**

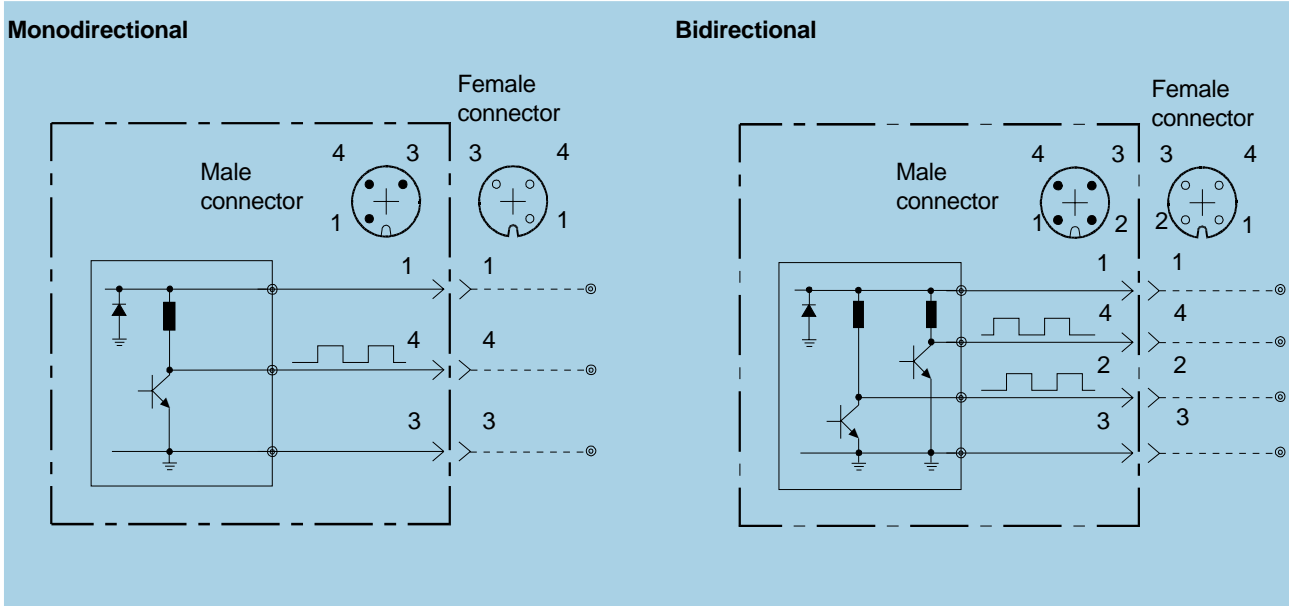

Color wires and function		
<b>1</b>	<b>Brown</b>	Power Supply (8 to 24 Vdc)
<b>2</b>	<b>White</b>	Output B phase (MAX 10 mA - 24 Vcc)
<b>3</b>	<b>Blue</b>	Power Supply (0 Vdc)
<b>4</b>	<b>Black</b>	Output A phase (MAX 10 mA - 24 Vcc)

**INCREMENTAL ENCODER  
TECHNICAL DATA**

Encoder type:	ELCIS mod. 478
Supply voltage:	8 to 24 Vcc
Current consumption:	120 mA max
Current output:	10 mA max
Output signal:	A phase- MONODIRECTIONAL A and B phase BIDIRECTIONAL
Response frequency:	100 KHz max
Number of pulses:	500 (others on request - max 2540)
Slew speed:	Always compatible with maximum motor speed
Operating temperature range:	from 32 to 158 °F
Storage temperature range:	from -22 to +185 °F
Ball bearing life:	1.5x10 <sup>9</sup> rpm
Weighth:	0,220 lb
Protection degree:	IP 67 (with protection and connector assembled)

Connectors:		
MONODIRECTIONAL	RSF3/0.5 M (Lumberg)	male
	RKT3-06/5m (Lumberg)	female
BIDIRECTIONAL	RSF4/0.5 M (Lumberg)	male
	RKT4-07/5m (Lumberg)	female

Note: Female connectors cable length equal to 16.4 foot (ft).

**STANDARD CONNECTION FLANGE**

Code "C1"

Flange is supplied complete with screws and seals.

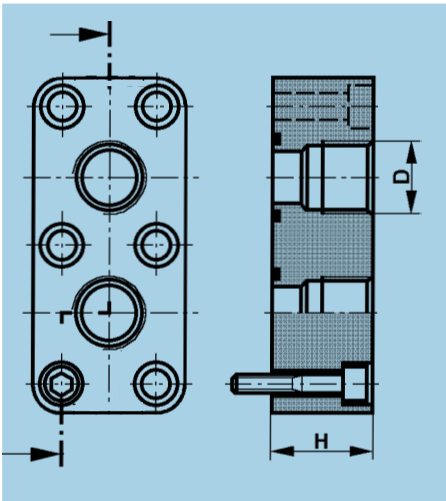

MR MRE	D (BSP)	H (inch)	CODE NBR	CODE FPM
<b>73 - 93 - 110</b> 125 - 160 -190 200 - 250 300 - 330	3/4"	1.42	262 098	229 394
<b>350 - 450</b> 500 600 - 700 800	1 1/4"	1.57	262 089	229 395
<b>1100 - 1400</b> 1600 - 1800 2100	1 1/2"	1.77	262 093	229 396
<b>2400 - 2800</b> 3100	1 1/2"	2.36	264 572	229 397
<b>3600 - 4500</b> 5400 6500 - 7000 8200	2"	2.36	272 724	229 398

BSP threads to ISO 228/1

Permitted up to 6000 PSI

**SAE CONNECTION FLANGE**

Codice "S1"

Codice "T1"

Codice "G1"

Codice "L1"

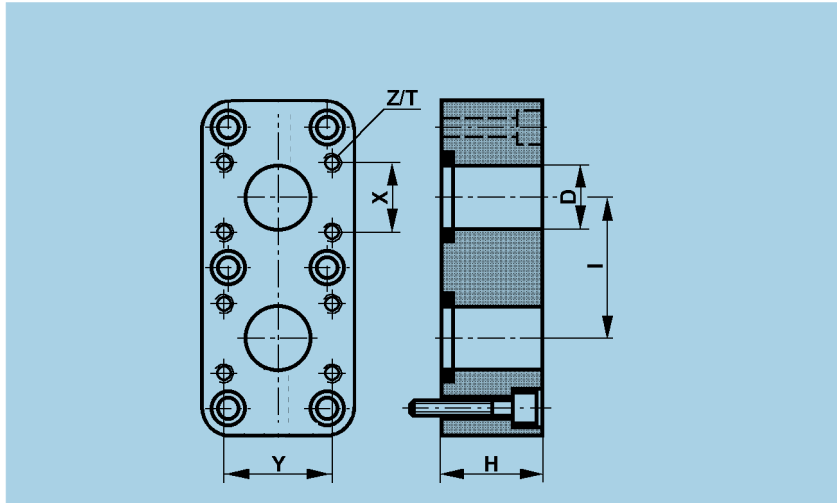

Flange is supplied complete with screws and seals. FPM seals enquiry.

MR MRE	SAE PSI	D		H (inch)	I (inch)	X (inch)	Y (inch)	METRIC		UNC		
		"	(inch)					Z (mm) T(inch)	Denison Calzoni part N° NBR	Z (")	T(inc- h)	Denison Calzoni part N° NBR
<b>73 - 93 - 110</b> 125 - 160 -190 200 - 250 300 - 330	5000	3/4"	0.748 (19 mm)	1.42	2.17	0.87	1.87	M10/0.98	277 295	3/8"-16	0.984	223 335
<b>350 - 450</b> 500 600 - 700 800	5000	1"	0.984 (25 mm)	1.57	2.36	1.03	2.06	M10/0.98	277 297	3/8"- 16	0.984	223 336
<b>1100 - 1400</b> 1800 - 1600 2100	4000	1 1/4"	1.220 (31 mm)	1.77	2.95	1.19	2.31	M10/0.98	277 299	7/16-14	1.18	223 337
	6000	1"	0.984 (25 mm)	1.77	2.80	1.09	2.25	M12/0.87	230 166	7/1614	1.18	342 092
<b>2400 - 2800</b> 3100	3000	1 1/2"	1.457 (37 mm)	2.36	3.39	1.41	2.75	M12/1.18	277 301	1/2"- 13	1.18	223 338
	6000	1 1/2"	1.457 (37 mm)	2.36	3.84	1.44	3.13	M16/1.18	230 168	5/8"-11	1.37	349068
<b>3600 - 4500</b> 5400 6500 - 7000 8200	3000	2"	1.969 (50 mm)	2.36	4.41	1.69	3.06	M12/1.18	277 303	1/2"-13	1.18	223 339
	6000	2"	1.969 (50 mm)	2.36	4.57	1.75	3.81	M20/1.38	230 170	3/4"- 10	1.49	342 547

COUPLINGS

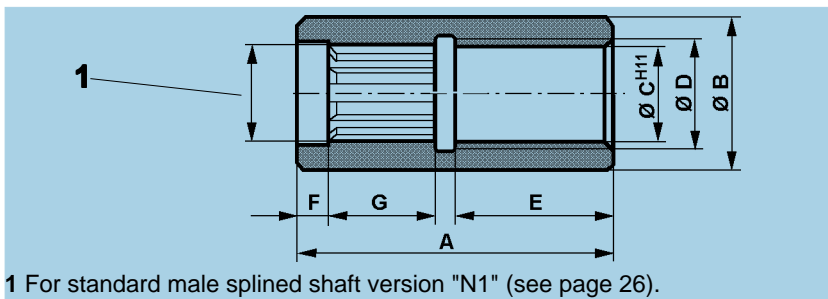

MR MRE	ORDERING CODE	A (inch)	B (inch)	CH1 (inch)	D (inch)	E (inch)	F (inch)	G (inch)
125 - 160 190	465 203	4.49	2.20	1.5417 1.5354 (39 mm)	1.85	2.13	0.61	1.36
250 - 300 330	465 202	5.31	2.80	1.9354 1.9291 (49 mm)	2.36	2.52	0.59	1.77
350 - 450 500	465 201	6.10	3.15	2.1728 2.1653 (55 mm)	2.68	2.68	0.73	2.19
600 - 700 800	465 200	6.73	3.54	2.4090 2.4016 (61 mm)	2.95	3.15	0.75	2.32
1100 1400	464 785	7.32	4.17	2.8814 2.8740 (73 mm)	3.48	3.37	0.79	2.58
1600 - 1800 2100	465199	8.82	4.65	3.2763 3.2677 (83 mm)	3.86	4.21	0.87	3.07
2400 - 2800 3100	465 198	10.43	5.20	3.6700 3.6614 (93 mm)	4.41	5	0.91	3.82
3600 - 4500 5400	474 692	13.98	5.91	4.4574 4.4488 (113 mm)	4.96	6.50	1.18	5.51
6500 - 7000 8200	422 544	15.35	7.68	4.9704 4.9606 (126 mm)	5.51	7.28	1.50	5.79

ADAPTERS WITH KEY

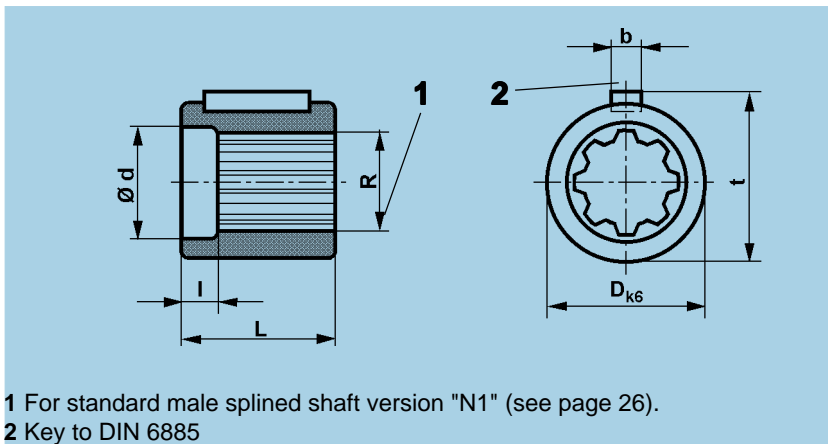

MR MRE	ORDERING CODE	R EX DIN 5463 (mm)	d (inch)	l (inch)	D <sub>k6</sub> (inch)	L (inch)	b (inch)	t (inch)	Key (mm) DIN 6885
125 - 160 190	271 117	A8x32x38	1.508	0.61	2.2842 2.2835 (58 mm)	1.97	0.39	2.40	10x8x45
250 - 300 330	271 118	A8x42x48	1.902	0.59	2.7567 2.7560 (70 mm)	2.36	0.55	2.89	14x9x56
350 - 450 500	271 119	A8x46x54	2.138	0.73	3.1504 3.1497 (80 mm)	2.95	0.63	3.31	16x10x70
600 - 700 800	271 120	A8x52x60	2.374	0.75	3.5442 3.5434 (90 mm)	3.15	0.71	3.70	18x11x70
1100 - 1400	271 121	A8x62x72	2.846	0.79	4.1348 4.1340 (105mm)	3.54	0.79	4.311	20x12x90
1600 - 1800 2100	271 122	A10x72x82	3.24	0.87	4.6466 4.6457 (118mm)	4.65	0.87	4.84	22x14x110
2400 - 2800 3100	271 123	A10x82x92	3.634	0.91	5.1191 5.1182 (130mm)	5.83	0.98	5.32	25x14x140
3600 - 4500 5400	272 719	A10x102x112	4.421	1.18	6.3002 6.2993 (160mm)	7.40	1.10	6.54	28x16x180
6500 - 7000 8200	223 476	A10x112x125	4.944	1.50	7.2847 7.2836 (185mm)	7.40	1.77	7.68	45x25x180

HOLDING BRAKE UNIT DIMENSIONS - MOTOR TYPE MR - MRE

BRAKE TYPE	B 190	B 300	B 450	B 700	B 1100	B 1800	B 2800
MOTOR TYPE MR - MRE	125 - 160 190	250 - 300 330	350 - 450 500	600 - 700 800	1100 - 1400	1600 - 1800 2100	2400 - 2800 3100

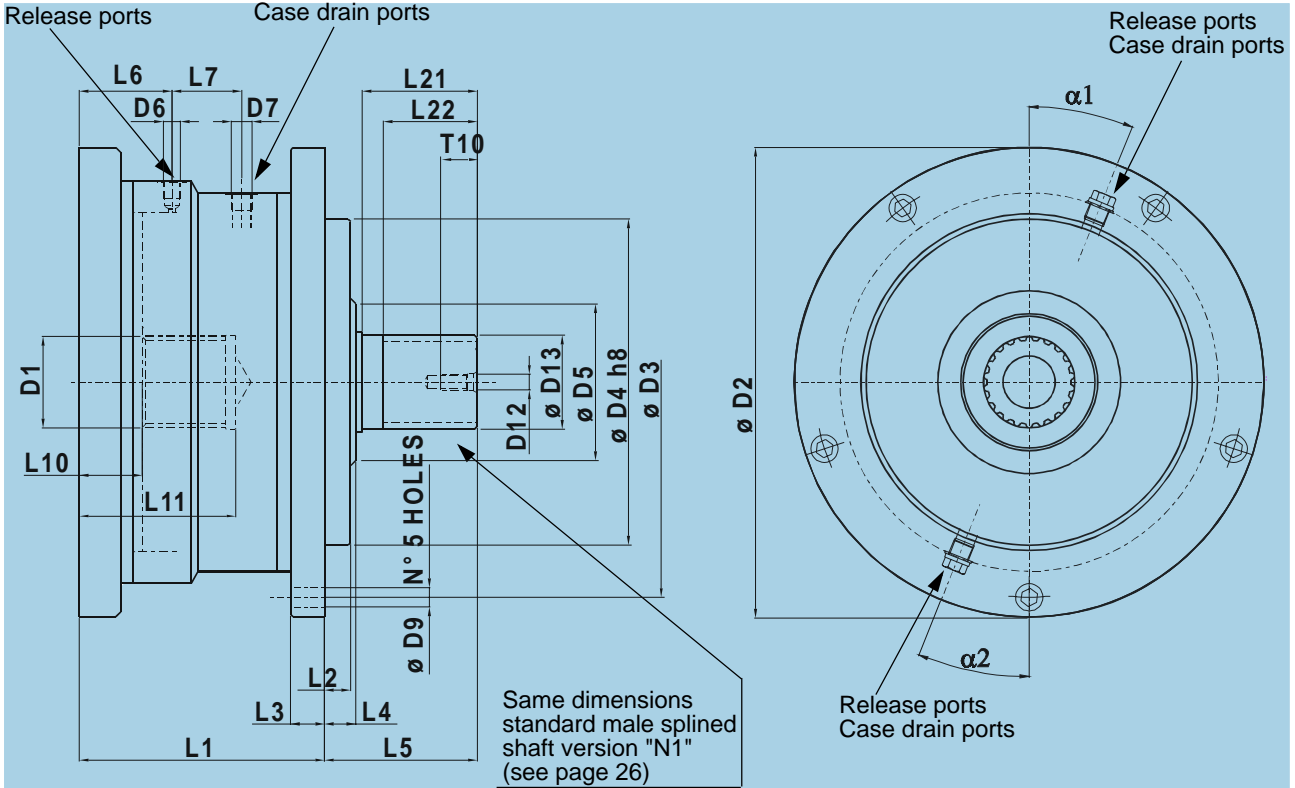

$\alpha 1, \alpha 2$  Corresponding angles to the release ports 1 and 2, to case the drain ports 1 and 2

BRAKE TYPE	L1 (inch)	L2 (inch)	L3 (inch)	L4 (inch)	L5 (inch)	L6 (inch)	L7 (inch)	L10 (inch)	L11 (inch)	L21 (inch)	L22 (inch)	D1 (mm)	D2 (inch)	D3 (inch)	D4 <sub>h8</sub> (inch)	D5 (inch)	D6 (BSP)	D7 (BSP)	D9 (inch)	D12 (inch)	D13 (mm)	T10 (inch)	$\alpha 1$	$\alpha 2$
B 190	4.76	-	0.87	0.55	2.64	1.61	1.15	0.79	2.84	1.97	1.40	N 38x 2x18-9H DIN 5480	9.84	8.86	6.2991 6.2967 (160 mm)	-	1/4"	3/8"	0.41	M12	B 8x32x38 ex DIN 5463	1.10	22°30'	22°30'
B 300	5.35	-	0.98	0.59	3.19	1.65	1.56	0.83	3.39	2.36	1.81	N 48x2x22-9H DIN 5480	10.08	9.13	6.8897 6.8872 (175 mm)	-	1/4"	3/8"	0.41	M12	B 8x42x48 ex DIN 5463	1.10	22°30'	22°30'
B 450	5.79	-	1.06	0.59	3.82	1.95	1.42	0.95	3.94	2.91	2.22	N 55x3x17-9H DIN 5480	11.65	10.47	7.4802 7.4774 (190 mm)	-	1/4"	3/8"	0.53	M12	B 8x46x54 ex DIN 5463	1.10	22°30'	22°30'
B 700	6.77	-	1.10	0.59	3.98	2.17	1.81	0.98	4.13	3.07	2.44	N 60x3x18-9H DIN 5480	12.60	11.42	8.6613 8.6585 (220 mm)	-	1/4"	3/8"	0.53	M12	B 8x52x60 ex DIN 5463	1.10	22°30'	22°30'
B 1100	7.40	0.79	1.02	0.95	4.61	2.80	2.11	1.89	4.72	3.47	2.84	N 70x3x22-9H DIN 5480	14.17	12.99	9.8424 9.8396 (250 mm)	4.72	1/4"	M16x- 1.5	0.59	M12	B 8x62x72 ex DIN 5463	1.10	0°	0°
B 1800	8.50	-	1.10	0.83	5.20	2.50	2.30	1.34	5.32	3.94	3.11	N 80x3x25-9H DIN 5480	16.65	14.96	11.4172 11.4141 (290 mm)	-	1/4"	1/2"	0.69	M12	B 10x72x82 ex DIN 5463	1.10	22°30'	22°30'
B 2800	10.35	-	1.18	0.95	6.02	3.43	2.64	1.67	6.50	4.72	3.90	N 90x4x21-9H DIN 5480	19.45	17.32	13.1889 13.1854 (335 mm)	-	1/4"	2"	0.75	M12	B 10x82x92 ex DIN 5463	1.10	22°30'	22°30'



TECHNICAL DATA

(For operation outside these parameters, please consult DENISON Calzoni)

CHARACTERISTICS		BRAKE TYPE						
		B 190	B 300	B 450	B 700	B 1100	B 1800	B 2800
STATIC BRAKING TORQUE	lbf.ft	922	1328	1955	2950	4573	8408	12612
DYNAMIC BRAKING TORQUE	lbf.ft	642	885	1069	1623	3098	4610	8851
RELEASE PRESSURE	psi	406	406	392	392	392	435	435
MAX. OPERATING PRESSURE	psi	6092	6092	6092	6092	6092	6092	6092
MOMENT OF INERTIA OF ROTATING PARTS	lbf.ft <sup>2</sup>	0.112	0.147	0.688	1.020	1.448	4.746	6.407
WEIGHT	lb	70.5	86	119	163	220,5	348.5	577.5
MOTOR TYPE MR MRE		125 160 190	250 300 330	350 450 500	600 700 800	1100 1400	1600 1800 2100	2400 2800 3100

CODE

Example: BRAKE - B 450 - N1 V1 \*\*

1. BRAKE - B 450 NI V1 \*\*

BRAKE TYPE

<b>B 190</b>	Brake for motor size "C"
<b>B 300</b>	Brake for motor size "D"
<b>B 450</b>	Brake for motor size "E"
<b>B 700</b>	Brake for motor size "F"
<b>B 1100</b>	Brake for motor size "G"
<b>B 1800</b>	Brake for motor size "H"
<b>B 2800</b>	Brake for motor size "I"

2. BRAKE - B 450 - N1 V1 \*\*

SHAFT

<b>N1</b>	Spline ex DIN 5463 (see page 26)
<b>D1 *</b>	Spline DIN 5480 (see page 26)
<b>F1 *</b>	Female spline DIN 5480 (see page 27)
<b>* please contact DENISON Calzoni</b>	

3. BRAKE - B 450 - N1 V1 \*\*

SEALS

<b>N1</b>	NBR: mineral oil
<b>V1 *</b>	FPM seals
<b>U1</b>	No shaft seal (for brake)
<b>* please contact DENISON Calzoni</b>	

4. BRAKE - B 450 - N1 V1 \*\*

SPECIAL

<b>**</b>	Space reserved to Denison Calzoni
-----------	-----------------------------------

**Mounting**

Any mounting position

- Note the position of the case drain port (see below)

Install the motor properly

- Mounting surface must be flat and resistant to bending

Min. tensile strength of mounting screws to DIN 267 Part 3 class 10.9

- Note the prescribed fastening torque

**Pipes, pipe connections**

Use suitable screws!

- Depending on type of motor use either threaded or flange connection

Choose pipes and hoses suitable for the installation

- Please note manufacturing data!

Before operation fill with hydraulic fluid

- Use the prescribed filter!

**NOTE:** Two of the mounting screws must be precisely located/fitted if operation is started and stopped frequently or if high reversible frequencies exist.

**Coupling**

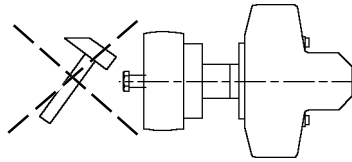

- Mounting with screws
- Use threaded bore in the drive shaft
- Take apart with extractor

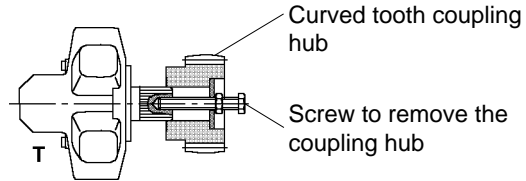

**DRAIN AND FLUSHING LINK INSTALLATION EXAMPLES**

**Note:** Position the case drain pipe, so that the motor **cannot run empty**.

T = Seal  
 Y = Motor housing feeding line  
 ← = Bleed

**Installation instructions for motors of the series "MR - MRE"**

Low pressure case drain returns to tank.

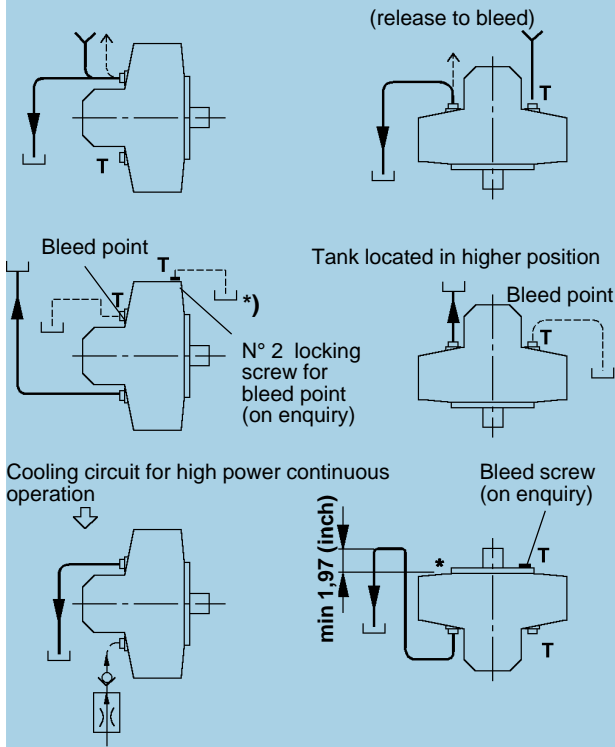

\*) Special designs for applications, where the equipment needs to be filled with oil.(e.g. in a salty atmosphere)

**Installation instructions for motors of the series "MR - MRE with brakes"**

Low pressure case drain returns to tank.

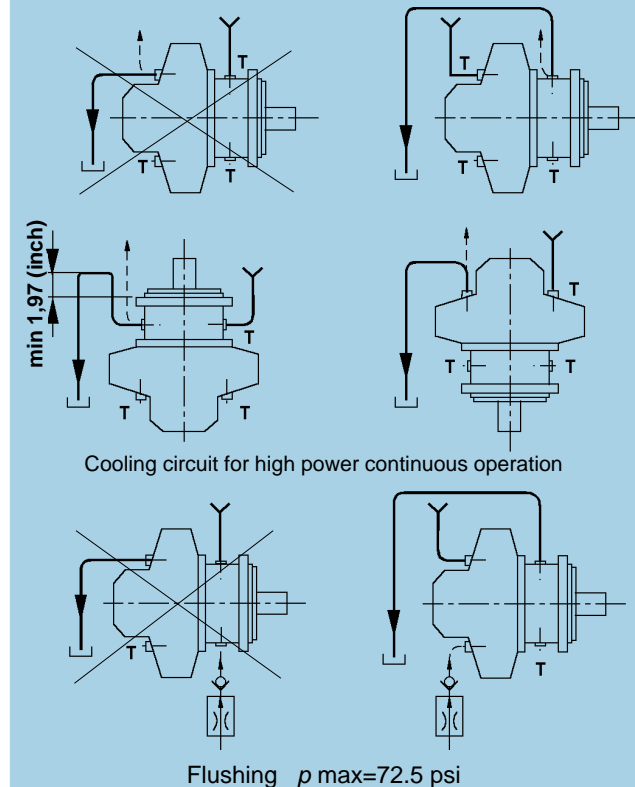

Motors without shaft seal used with brake

**CODE**

Example: MR 160C - N1 M1 F1 N1 N \*\*

1. MR 160C - N1 M1 F1 N1 N \*\*  
**SERIES**

<b>MR</b>	standard 3626 psi max. continuous
<b>MRE</b>	expanded 3046 psi max. continuous

2. MR 160C - N1 M1 F1 N1 N \*\*

**SIZE & DISPLACEMENT**

<b>A</b>	code	<b>MR 33 A</b>	<b>MR 57 A</b>		
	in <sup>3</sup>	1.96	3.44		
<b>B</b>	code	<b>MR 73 B</b>	<b>MR 93 B</b>	<b>MR110 B</b>	
	in <sup>3</sup>	4.43	5.65	6.65	
<b>C</b>	code	<b>MR 125 C</b>	<b>MR 160 C</b>	<b>MR 190 C</b>	
	in <sup>3</sup>	7.61	9.75	11.69	
<b>D</b>	code	<b>MR 200 D</b>	<b>MR 250 D</b>	<b>MR 300 D</b>	<b>MRE 330 D</b>
	in <sup>3</sup>	12.16	15.31	18.56	20.28
<b>E</b>	code	<b>MR 350 E</b>	<b>MR 450 E</b>	<b>MRE 500 E</b>	
	in <sup>3</sup>	21.33	27.56	30.38	
<b>F</b>	code	<b>MR 600 F</b>	<b>MR 700 F</b>	<b>MRE 800 F</b>	
	in <sup>3</sup>	37.10	43.09	49.08	
<b>G</b>	code	<b>MR 1100 G</b>	<b>MRE 1400 G</b>		
	in <sup>3</sup>	68.7	83.6		
<b>H</b>	code	<b>MR 1600 H</b>	<b>MR 1800 H</b>	<b>MRE 2100 H</b>	
	in <sup>3</sup>	97.5	110.4	127.6	
<b>I</b>	code	<b>MR 2400 I</b>	<b>MR 2800 I</b>	<b>MRE 3100 I</b>	
	in <sup>3</sup>	139.9	170.4	189.4	
<b>L</b>	code	<b>MR 3600 L</b>	<b>MR 4500 L</b>	<b>MRE 5400 L</b>	
	in <sup>3</sup>	221.9	274.8	329.6	
<b>M</b>	code	<b>MR 6500 M</b>	<b>MR 7000 M</b>	<b>MRE 8200 M</b>	
	in <sup>3</sup>	394.2	408.7	502	

3. MR 160C - N1 M1 F1 N1 N \*\*

**SHAFT**

<b>N1</b>	spline ex DIN 5463 (see page 26)
<b>D1</b>	spline DIN 5480 (see page 26)
<b>F1</b>	female spline DIN 5480 (see page 27)
<b>P1</b>	shaft with key (see page 27)
<b>B1</b>	spline B.S. 3550 (see page 26)

4. MR 160C - N1 M1 F1 N1 N \*\*

**SPEED SENSOR OPTION**

<b>N1</b>	none	
<b>Q1</b>	encoder drive (see page 28)	
<b>C1</b>	mechanical tachometer drive (see page 28)	
<b>T1</b>	tachogenerator drive (see page 28)	
<b>M1</b>	incremental Elcis encoder	Uni-directional
<b>B1</b>	( 500 pulse/rev) (see page 28)	Bi-directional

5. MR 160C - N1 M1 F1 N1 N \*\*

**SEALS**

<b>N1</b>	NBR mineral oil
<b>F1</b>	NBR, 218 psi shaft seal
<b>V1</b>	FPM seals
<b>U1</b>	no shaft seal (for brake)

6. MR 160C - N1 M1 F1 N1 N \*\*

**CONNECTION FLANGE**

<b>N1</b>	none
<b>C1</b>	standard DENISON Calzoni (see page 30)
<b>S1</b>	standard SAE metric (see page 30)
<b>T1</b>	standard SAE UNC (see page 30)
<b>G1</b>	SAE 6000 psi metric (see page 30)
<b>L1</b>	SAE 6000 psi UNC (see page 30)

7. MR 160C - N1 M1 F1 N1 N \*\*  
**ROTATION**

<b>N</b>	standard rotation (CW: inlet in A, CCW: inlet in B)
<b>S</b>	reversed rotation (CW: inlet in B, CCW: inlet in A)

8. MR 160C - N1 M1 F1 N1 N \*\*  
**SPECIAL**

<b>**</b>	space reserved to Denison Calzoni
-----------	-----------------------------------

**International Distributors****In Europe :**

Cyprus  
Czech Republic  
Greece  
Hungary  
Iceland  
Jugoslavia  
Norway  
Portugal  
Poland  
Romania  
Russia  
Slovakia  
Slovenia  
Switzerland  
The Faroe Islands  
Turkey

**In Africa :**

Algeria  
Egypt  
Ivory Coast  
Morocco  
Nigeria  
South Africa  
Tunisia

**In Middle East :**

Bahrain  
Iran  
Israel  
Jordan  
Kuwait  
Lebanon  
Pakistan  
Qatar  
Saudi Arabia  
Syria  
United Arab Emirates

**In Far East :**

Indonesia  
Korea  
Malaysia  
New Zealand  
Philippines  
Thailand

**South-America :**

Argentina  
Brazil  
Chile  
Colombia  
Ecuador  
Mexico  
Peru  
Venezuela

**Denison Calzoni S.p.a.**  
Via Caduti di Sabbiano 15/17  
40011 Anzola dell'Emilia  
Bologna Italy  
Tel: +39 (051) 6501611  
Fax: +39 (051) 736221  
e-mail: rco@rco.it

**Asia-Pacific****Australia**

Denison Hydraulics PTY  
41-43 St Hilliers Road  
P.O.Box 192  
Auburn N.S.W. 2144, Australia  
Tel : +61 (2) 9646 5200  
Fax : +61 (2) 9643 1305

**Hong Kong**

Denison Hydraulics Ltd.  
Unit 6A, 33/F Cable TV Tower  
9 Hoi Shing Road, Tsuen Wan  
NT, Hong Kong  
Tel : +852 2498 8381  
Fax : +852 2499 1522

**Japan**

Denison Japan Inc.  
4-2-1 Tsujido-Shinmachi  
Fujisawa 251, Japan  
Tel : +81 (466) 35-3050  
Fax : +81 (466) 35-2019

**China**

Denison Hydraulics Engineering Ltd.  
Room 8018, No. 601, Zhang Yang  
Road Pudong New Area  
Shanghai 200120, China  
Tel : +86 (21) 58205042 / 58205034  
Fax : +86 (21) 58205014

**Singapore**

Denison Hydraulics Sea Pte LTD  
Blk 5#06-12  
Ang Mo Kio Industrial Park 2A  
Singapore 567760  
Tel : +65 6268 7840  
Fax : +65 6268 7847

**Taiwan**

Denison Hydraulics LTD  
6F-10. No. 79, Sec. 2  
Roosevelt Road, Taipei  
Tel : +65 268 7840  
Fax : +65 268 7847

**Europe****Austria**

Denison Hydraulics GmbH  
Zweigvertriebsstelle Linz  
Haibachstraße 69  
4061 Pasching, Austria  
Tel : +43 (72 29) 48 87  
Fax : +43 (72 29) 6 30 92

**Benelux**

Denison Hydraulics Benelux B.V.  
Pascalstraat 100  
3316 GR Dordrecht, Holland  
Tel : +31 (78) 6179 900  
Fax : +31 (78) 6175 755

**Denmark**

Denison Hydraulics Denmark A/S  
Industrikrogen 2  
2635 Ishøj, Denmark  
Tel : +45 (4371) 15 00  
Fax : +45 (4371) 15 16

**Finland**

Denison Lokomec OY  
Polunmäenkatu 22  
P.O.Box 116  
33721 Tampere, Finland  
Tel : + 358 (3) 3575 100  
Fax : + 358 (3) 3575 111

**France**

Denison Hydraulics France S.A.  
14 route du bois blanc  
BP 539  
18105 Vierzon, Cedex, France  
Tel : +33 (2) 48 53 01 20  
Fax : +33 (2) 48 75 02 91

**Great Britain**

Denison Hydraulics UK LTD  
Kenmore road  
Wakefield 41, Industrial Park  
Wakefield, WF2 OXE  
West Yorkshire, England  
Tel : +44 (1924) 826 021  
Fax : +44 (1924) 826 146

**Germany**

Denison Hydraulik GmbH.  
Auf dem Sand 14  
D-40721 Hilden, Germany  
Tel : +49 (2103) 940 300  
Fax : +49 (2103) 940 558

**Italy**

Denison Hydraulics Italy Srl  
Viale Europa 68  
20090 Cusago (MI), Italy  
Tel : +39 (02) 90330-1  
Fax : +39 (02) 90390694/5/6

Denison Calzoni S.p.A  
Via Caduti di Sabbiano 15/17  
40011 Anzola dell'Emilia  
Bologna, Italy  
Tel : +39 (051) 6501611  
Fax : +39 (051) 736221

**Spain**

Denison Hydraulics S.A.  
Poligono "La Post"  
C/ Enginy n°.6, Nave 8  
08850 Gava, Barcelona, Spain  
Tel : +34 (93) 635 5170  
Fax : +34 (93) 635 5178

**Sweden**

Denison Hydraulics Svenska AB  
Sporregatan 13  
213 77 - Malmö, Sweden  
Tel : +46 (40) 600 13 00  
Fax : +46 (40) 600 13 50

**North America****Canada**

Denison Hydraulics Canada Inc.  
2880 Brighton Road, Unit 1  
Oakville, ON L6H 5S3, Canada  
Tel : +1 (905) 829 5800  
Fax : +1 (905) 829 5805

**Mexico, Central America,  
South America, Caribbean  
countries**

Denison Hydraulics Corp.  
6167 NW 181 Terrace Circle  
North  
Miami, FL 33015, USA  
Tel : +1 (305) 362 2246  
Fax : +1 (305) 362 2246

**USA**

Denison Hydraulics Inc.  
14249 Industrial Parkway  
Marysville, OH 43040-9551,  
USA  
Tel : +1 (937) 644 3915  
Fax : +1 (937) 642 3738

**Others****Other European, Middle East,  
African countries**

Denison Hydraulics France S.A  
14 route du bois blanc  
BP 539  
18105 Vierzon, France  
Tel : +33 (2) 48 53 01 20  
Fax : +33 (2) 48 53 01 46

Your local Denison Hydraulics representative

**DENISON** CALZONI